

MELVIN'S CLASSIC FORD PARTS



1970-1977 Ford Maverick
&
1971-1977 Mercury Comet

2017 - Catalog

Prices Are Subject To Change



Owner: Paul Masson of
New Brunswick, Canada
Photo By: Paul Masson

MELVIN'S CLASSIC FORD PARTS

We sell only the best available!



About the Cover

Paul's 1971 Maverick Grabber was purchased from the 2nd owner in 2012 with just over 19,000 original miles on the odometer. After shipping the car over 1,200 miles to Canada and driving the car for a few weeks, it was discovered that the cowl area required replacing. From Jan 2013 until June 2016, the car was completely dismantled, the cowl was replaced and engine bay and interior were freshened-up, along with adding 5-lug disc brakes and Factory Aluminum Slots to all four corners. The car still wears 90% of its original Grabber Yellow exterior paint. Paul restored/built this car in memory of his late father, who was responsible for getting Paul interested in Mavericks and Comets at the age of 14. The Grabber now serves as a memory-maker for Paul, his wife and their two children.



MELVIN'S CLASSIC FORD PARTS

Mustang | Falcon | Galaxie | Truck | Model A | Street Mod | 1932-59 Cars | Thunderbird | Fairlane | Maverick

Dear Maverick and Comet owners,

Well, the time has come for us to face the music and retire. You will all be glad to hear that Melvin's Classic Ford Parts will continue under the capable hands of Randy, our youngest son. Most of you will remember him starting out with us when he was 12 years old and we had to drag him to car shows. How time flies when you are having fun! He worked with us from 1993 until 2011 and now he is back. We will continue to help him out until he gets "re-adjusted" and "back in the groove." You will also be happy to hear that Jessica will continue to work with Randy. She has been working with us for the past 25 years and Randy could not take on this task without her help! Randy will probably be relocating in the future and we will keep everyone updated. Melvin will continue his passion at home, working on his many projects—we might actually be able to go to some car shows and act like spectators finally.

Way back in 1987, Melvin's Classic Ford Parts was started by selling a boat and buying Gary Goddard's Falcon and Mustang parts business. Melvin has always had old Fords, since he was 15 years old, so the dream was to have his own Ford business. This was just going to be a little thing to go to car shows on the weekend with a little mail-order business added on. Our first car show was in Clarksville, Georgia—true story—we loaded up our parts in our Chevrolet truck (just because we got it cheap) and put out our little display; we had a guy walk up and say, "I need some Ford parts, but you are driving a Chevrolet so I will keep going!" Needless to say the following week we traded that Chevrolet truck for a Ford truck!! We purchased our first trailer from Jim Johnson, JJ's Mustang, until we outgrew it. We traveled to car shows for the first ten years, meeting wonderful people along the way, but that is a lot of hard work. We moved into our Conyers location in 1999.

If we can pass along one piece of advice that we have learned over the years, is that you usually get what you pay for. On so many of the reproduction parts, there are several manufacturers and they do not always produce a quality part. Melvin actually restores his own vehicles and does not farm out anything. If he does not like the quality or fit of a part then we do not sell it. Of course, there is always the possibility of only one manufacturer on a part and then you do not have a choice unless you go with an NOS part—and those are getting few and far between.

Please continue to support our wonderful hobby and hopefully Randy and Jessica will be able to retire one day. It would be wonderful for our little family business to continue for years to come. Who knows, with three grandsons now, anything is possible.

Please be sure to swing by and visit Randy and Jessica when you are near Atlanta; we are only about 20 minutes from downtown and the airport.

We want to thank everyone for an incredible 29 years. It's been a great ride!

—Melvin & Vicky



About Us

Melvin's Classic Ford Parts, Inc. is a family owned and operated company that has been serving the Ford enthusiast since 1987. Our family includes: Melvin, Vicky, Randy and Jessica. We moved into our new, larger facility located in Conyers, Ga. in October 1999. Sadly, Melvin decided to retire at the end of 2016. Melvin's Classic Ford Parts will continue under the capable hands of Randy, our youngest son, he worked with us from 1993 until 2011 & now he is back. We will continue to help him out until he gets "re-adjusted" & "back in the groove". You will also be happy to hear that Jessica will continue to work with Randy. She has been working with us for the past 25 years & Randy could not take on this task without her help! Randy will be relocating to 1390 Business Center Drive, Suite 100, Conyers, Ga. 30094. Please be sure to swing by & visit Randy & Jessica when you are near Atlanta-we are only about 20 minutes from downtown & the airport.

Melvin has always had old Fords - from Model A's to Mustangs. Currently we have a 1939 Convertible, 1939 Standard Coupe, 1965 Falcon Ranchero, 3 Mustangs, 1968 Shelby GT350, 1966 Pickup, 1 Cushman Eagle, and 1 Cushman Truckster! We belong to the Mustang Club of America (Charter Member #15), Falcon Club of America, Fairlane Club of America and AACA. Our goal is not to be the largest supplier - just the only place you will need to shop.

Our catalogs feature the highest quality parts available for your classic restoration. Look for products from manufacturers SUCH as: Scott Drake Reproductions, Dennis Carpenter, Pro Products, AMK, American Designers, Ford Motorsports, Re-Pops, Auto Custom Carpet, Marti Auto Works, Custom AutoSound, American Cushion, and Daniel Carpenter. These manufactures produce only the finest products. If Melvin won't use it on his cars, then we don't carry it! We price very competitively. Keep in mind, there are varying qualities in parts and you get what you pay for. We try to keep 90% of all merchandise in stock for immediate shipping; which is currently over 16,000 different part numbers! We have quite a large inventory for all "Classic Fords". This is the reason for the store credit policy. We want to have what you want, when you want it!

Whether it is a hard to find part or a standard replacement part, Melvin's has what you are looking for. Give us a call if you cannot find what you need. We will be happy to help!

1390 Business Center Dr.

Suite 100

Conyers, GA 30012

Sales: 770-761-6800

Fax: 770-761-5777

***** Due to the fluctuation in price of petroleum and metal, prices are subject to change!! *****

Ordering Info & Policies

Please read the Ordering Information carefully & thoroughly. If you have any questions please feel free to call. We will be delighted to answer any questions. Be sure to check your car and order the correct parts. If you are not sure please ask before ordering. It will save us both time & money!

Payment method:

We accept Visa, Mastercard, Discover & American Express.

Shipping & Handling:

UPS is our primary shipping course. Call for other options. Canada: Add 20% for S & H (We are not responsible for customs or duty tax) Overseas: Shipping quotes available upon request. Fragile items, such as molding, will be shipped in PVC tubes & will have an additional \$10.00 fee. Oversize items, such as sheetmetal, bumpers, etc. will have an additional \$10.00 fee.

Backorders:

If an item is out of stock, it will be shipped as soon as possible. Please check your receipt for any notations. Please call & cancel any backorder if you do not want to wait.

Truck shipments:

All orders too large for UPS or Federal Express must be shipped by truck & must be prepaid by Bank Cashier's Check or Postal Money Order. No credit card or C.O.D. Please be sure to inspect parts while the driver is still there.

Damaged merchandise:

Damage in transit is the responsibility of the carrier, not Melvin's Classic Ford Parts. If you receive an opened or damaged package, inspect it in the presence of the carrier & have the driver note "Damage" on the delivery sheet. Contact your local UPS or Truck line. Please keep merchandise in the original box.

Special Orders:

These are items that are not stocked parts. These must be prepaid with Cash, Postal Money Order or Bank Carrier's Check. No Credit Card. No return or exchange on special orders. These parts cannot be returned for any reason other than defects in material or workmanship.

Returns:

Can be returned for exchange or store credit within 15 days from date of invoice. Please call for return authorization number. After 15 days a 20% restocking fee will be charged. After 30 days a 30% restocking fee. After 60 days a 50% restocking fee. All new products are guaranteed against defects in workmanship & material. Liability to Melvin's Classic Ford Parts is limited to the replacement of the defective parts. All items returned must be in "New" condition & in the original packaging. No return on electrical, literature, stripe kits, paint or special orders. You must include a copy of your original invoice or it cannot be returned.

Disclaimer:

Melvin's Classic Ford Parts, Inc. will not be responsible for any loss or damage caused by delays or any damage caused by the replacement of a defective part nor the labor or transportation incurred. Our obligation is to replace the defective parts. We are not liable for the use or misuse of any of our products. We are not responsible for any typographical errors.

Used Parts & N.O.S. Parts:

We will do our best to describe parts to you-we can e-mail you a picture if you like, but please understand that there is NO RETURN on these parts.



Melvin's Classic Ford Parts

1970-1977 - Ford Maverick

1971-1977 - Mercury Comet

Maverick/Comet

accessories pg. 1-2
air conditioning pg. 3-6
battery pg. 7-8
brakes pg. 9-16
clips / retainers pg. 17-21
clutch pg. 22-25
console / shifter pg. 26-28
dash pg. 29-30
decals pg. 31-34
doors pg. 35-37
electrical pg. 38-44
engine pg. 45-52
exhaust pg. 53
exterior pg. 54-55
fuel pg. 56-59
hardware pg. 60-71
heater pg. 72-73
interior pg. 74-82
lights pg. 83-87
locks pg. 88
mirrors pg. 89-90
paint & restoration supplies pg. 91-94
radiator pg. 95-96
radio related pg. 97-98
rubber plugs / plugs / grommets pg. 99-101
sheet metal pg. 102-103
steering pg. 104-107
stripes & graphics pg. 108-109
suspension pg. 110-113
tools pg. 114-115
transmission pg. 116-120
trunk pg. 121-123
weatherstripping pg. 124-126
wheels pg. 127-128
wiper pg. 129-130
literature pg. 131
index
club information

Accessories

BATTERY BOX RELOCATION KIT



13-1/2" Long X 9-1/2" Wide X 10" High- Not NHRA Legal
ENG658-039.....169.95

CAR COVER ANTENNA GROMMET



- Installs on Car Cover to allow use of stock antenna -
 - Snaps together to prevent car cover from tearing -
CC-AG.....3.00

CAR DUSTER (SMALL)



90203.....9.95

COOLER



Vintage Ford-Blue
U-1100-BFL.....99.00

EMBLEM



-Self adhesive -Plastic
 302 HIGH PERFORMANCE-RED
302-HP-R.....15.00
 302 HIGH PERFORMANCE-BLUE
302-HP-B.....15.00
 302
302-S3.....15.00

EMBLEM



- Self adhesive -Plastic
 HIGH PERFORMANCE-CHROME/BLK
HP-S4.....15.00

FENDER COVER



FC3...(black w/Ford Oval).....29.95
FC12...(black w/Mercury).....29.95

HEADLIGHT COVER SHIELD 7 1/2"



A13004A...(pr).....8.00

HEADLIGHT VISOR 7 1/2"



10467...(ea).....8.00

TIN SIGNS



Perfect for your Man Cave or Garage!
 Please visit the Accessories section of our website for these
 and many others to choose from.
Each.....12.95



Accessories

HUMPHUGGER - CONSOLE



- Available in Black, Blue, White & Red
FFHH6473-(specify color).....125.00

KEY CHAIN



KC1...(Ford oval, Metal).....5.00
ACC-FORD...(w/Ford oval, black leather).....8.00

LICENSE PLATES - FORD



LS2501-1...(laser cut - black w/blue Ford Oval).....30.00
SS1531-1...(Ford Racing).....30.00
SS1501-1...(Stainless Steel Ford Blue Oval).....30.00
SS1501-2...(Stainless Steel Ford Black Ford Oval).....30.00
SS2501STMP-3DP...(Stainless Diamond Plate Ford Oval).....35.00

LICENSE PLATES - MERCURY



LS2728-1...(Mercury Man-black).....30.00
SS3728-1...(S/S).....35.00
SS1728-1...(Mercury Man-stainless).....30.00
LS2729-1...(Mercury script).....30.00
SS1729-1...(Mercury script-stainless).....30.00

***** PRICES ARE SUBJECT TO CHANGE*****
 See disclaimer in front of catalog. Refer to website for current pricing. Confirm prices upon ordering.

LICENSE PLATE BOLTS



- Glass Reflector
LP2A.....10.50
LP2RED.....10.50
LP2BLUE.....10.50
LP2GREEN.....10.50

LICENSE PLATE FRAMES



5501LO-A...(chrome w/Ford logo).....30.00
5501LO-B...(chrome w/double Ford logo).....30.00

MAGNETIC SIGN- "LOOK AND ENJOY"



MM3.....4.50

MAGNETIC SIGN - "LOOK BUT PLEASE DON'T TOUCH"



MM2.....4.50

OWNERS PLATE



Universal – Brass
U18651OP.....8.95

TRUNK RELEASE KIT



Chrome Handle Cable Is 160"
 - Handle Mounts on Floor by Driver's Seat
C7AZ62432A00A.....59.95

Air Conditioning

A/C COMPRESSOR (w/Integral A/C)



71-77 Maverick & Comet
58022...(302 & w/clutch).....**350.00**
58064...(6cyl & w/o clutch).....**295.00**

COMPRESSOR CLUTCH BRUSH SET



70-77 Maverick & 71-77 Comet
8-107.....**45.00**

A/C COMPRESSOR CRANKSHAFT SEAL KIT



70-77 Maverick & 71-77 Comet
 All w/Integral A/C & York Compressor
C9AZ19655B.....**20.00**

COMPRESSOR SWITCH



72 Maverick w/hang on A/C
C8SZ2979A.....**38.00**

COMPRESSOR COVER



70-77 Maverick & 71-77 Comet
 - All w/York Compressor
C5ZZ19703PP...(plain).....**49.95**



COMPRESSOR METAL TAG



- Nice addition to any Maverick or Comet
DF351...(Ford).....**5.00**
DL267...(Mercury).....**6.50**
13881...(tag retainer).....**4.00**

COMPRESSOR MOUNTING BRACKET



71-73 Maverick & Comet
7-139...(302).....**95.95**

COMPRESSOR IDLER BRACE



71-77 Maverick & Comet
7-155...(302).....**80.00**

IDLER PULLEY / BELT TENSIONER



72-77 Maverick & Comet
7-150...(302).....**75.00**



Air Conditioning

A/C PULLEY - V8



71-77 Maverick & Comet
7-120...(302).....99.00

CONDENSER

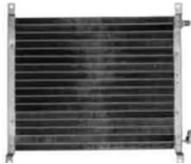

71-77 Maverick & Comet
C11-127.....329.95

A/C LINE GROMMET

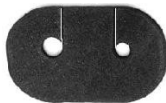

70-77 Maverick & 71-77 Comet w/Integral A/C
- Protects A/C Lines as they pass through radiator support
- Must Glue to existing Bracket
C7ZZ19819.....3.00

LINE GROMMETS AT RADIATOR SUPPORT



71-72 Maverick & Comet
6 cyl. Hang-on AC only
378264S...(pr).....9.95

A/C HOSES



71-73 Maverick & Comet
13-122...(discharge hose for V8 Ford compressor).....75.00
71-73 Maverick & Comet
13-132...(discharge hose for V8 Sanden compressor).....80.00
70-73 Maverick & 71-73 Comet
13-133...(suction hose for 6 cyl Sanden compressor).....80.00
70-73 Maverick & 71-73 Comet
13-115...(suction hose for 6 cyl Ford compressor).....85.00
73 Maverick & Comet
13-134...(suction hose for V8 Sanden compressor).....80.00
73 Maverick & Comet
13-116...(suction hose for V8 Ford compressor).....95.00

SERVICE VALVE



70 Maverick (Before 12/1/69)
14-103...(#8 O'ring/roto discharge side).....33.00
14-104...(#10 O'ring/roto suction side).....33.00
70-73 Maverick (after 12/1/69) & 71-73 Comet
-To 3/1/73 for both Maverick and Comet
14-105...(#8 O'ring/roto discharge side).....33.00
14-106...(#10 O'ring/roto suction side).....33.00

SERVICE VALVE CAPS



70-73 Maverick & 71-73 Comet
14-107...(pr).....24.95



**Melvin's Classic
Ford Parts
PHONE: 770-761-6800**



Air Conditioning

A/C QUICK DISCONNECT FITTING



73-77 Maverick & Comet
14-110.....24.95

ACCUMULATOR/DRIER (w/Integral A/C)



70-71 Maverick & 71 Comet (Before 8/2/71)
33274.....39.95
 71-73 Maverick & Comet (From 8/2/71)
33371.....39.95
 74-75 Maverick & Comet (Before 2/23/75)
33329.....39.95
 75-77 Maverick & Comet (From 2/23/75)
33371.....39.95

EXPANSION VALVE (w/Integral A/C)



70-77 Maverick & 71-77 Comet
38901.....24.95

EXPANSION VALVE (w/Hang-On/Dealer A/C)



70-77 Maverick & 71-77 Comet
15-103.....85.00

THERMOSTAT (w/Integral A/C)



70-77 Maverick & 71-77 Comet
 - Cosmetically it **may** appear different than your original, but the function is the same.
16-104.....55.00

**VISIT US ON THE WEB AT:
WWW.MELVINSCLASSICFORDPARTS.COM**

VACUUM CANISTER



70-77 Maverick & 71-77 Comet
 - This is correct for 71-73 Mustangs, the bracket has studs attached requiring nuts to be installed on back side of apron.
3-117.....95.00

VACUUM CONTROL MOTOR ASSY (w/Integral A/C)



71-77 Maverick & Comet
3-104.....79.95

VACUUM SWITCH (w/Integral A/C)



71-77 Maverick & Comet
 - Must reuse original bracket. Mounts on the main air chamber and opens and closes the air vent and heat valve. Made of nylon with a steel and brass plunger.
3-108.....60.00

BLOWER MOTOR RESISTOR



70-75 Maverick & 71-75 Comet
 *This is correct for 68-73 Mustangs with A/C, but can be used on A/C equipped 70-75 Mavericks & 71-75 Comets, may have to trim red fiber board to fit placement on fan housing.
C8ZZ19A706A...(factory A/C equipped).....22.00

MICRO SWITCH



70-72 Maverick & 71-72 Comet
 - Attaches to dash mounted controls
16-143.....29.00

Air Conditioning

A/C VENTILATION HOSE



70-77 Maverick & 71-77 Comet
 - Attaches to Distribution Housing behind center of dash and feeds air to register attached on each side of lower dash. Exact in color and material as original. Must cut to fit and attach any existing brackets from old hose to new hose.
FAA18584-2.5...(3 FEET).....25.00

A/C BOX CLIP



70-77 Maverick & 71-77 Comet
C0DF19A779A...(ea).....2.50

CABLE CLAMP & SCREW



70-77 Maverick & 71-77 Comet
 - Secures cable to A/C box
PE373.....6.00

FRESH AIR - INLET GASKET



70-77 Maverick & 71-77 Comet
 - Mount between Heater Box & Cowl
C5ZZ18A569A.....5.00

A/C DRAIN HOSE CLAMP



70-77 Maverick & 71-77 Comet
 Exact OEM replacement
5358......65

**VISIT US ON THE WEB AT:
WWW.MELVINSCCLASSICFORDPARTS.COM**

A/C DRAIN HOSE GROMMET



- Used on Transmission tunnel for tight seal around drain hose.
 70-77 Maverick & 71-77 Comet
 Only one (1) Required, Sold as a Pair
382745.....15.00

HEATER CONTROL VALVE



70-77 Maverick & 71-77 Comet
D0DZ18495A...(70-74, 6cyl & 75-76, 6 & V8 before 5/3/76).....115.00
D4AZ18495A...(76-77, 6cyl & V8 after 5/3/76).....45.00



UPS NEXT DAY & 2nd DAY AIR AVAILABLE

Battery

AUTOLITE BATTERY - REPRODUCTION



70-72 Maverick & 71-72 Comet
24FAUTOLITES.....299.00

AUTOLITE BATTERY COVER



70-72 Maverick & 71-72 Comet
24FCOVER...(good).....35.00
C1DZ10655BC...(best).....59.95

BATTERY TRAY



70-77 Maverick & 71-77 Comet
 - Must reuse original bracket
C6OZ10732.....14.95

BATTERY TRAY REINFORCEMENT PLATE



70-77 Maverick & 71-77 Comet
 - Correct for 68 Mustangs & Cougars, but works very well-
C8ZZ16060AR.....36.95

BATTERY TRAY HARDWARE KIT



73-77 Maverick & Comet
AMK140.....6.75



BATTERY MAT



- 8" X 12" Protects against battery acid-
 70-77 Maverick & 71-77 Comet
BATMAT.....5.95

BATTERY CLAMP "J" BOLT



70-77 Maverick & 71-77 Comet
PE417...(ea).....2.00
PE417SS...(stainless steel...pr).....14.95

APRON TO J-BOLT "L" BRACKET



70-77 Maverick & 71-77 Comet
C9ZZ10A705A.....14.45

BATTERY HOLDDOWN CLAMP



70-77 Maverick & 71-77 Comet
D0DZ10718B...(70-73).....14.50
D4MY10718A...(74-77).....14.50

BATTERY CABLES



70-77 Maverick & 71-77 Comet
BC4...(170-200).....60.00
BC11...(250-302).....60.00

***** PRICES ARE SUBJECT TO CHANGE*****
 See disclaimer in front of catalog. Refer to website for
 current pricing. Confirm prices upon ordering.

Battery

BATTERY CABLE TO SOLENOID BRACKET



70-77 Maverick & 71-77 Comet
 - Mounts to Right Hand Side of Engine
BC9.....7.00

BATTERY CORROSION PROTECTORS



70-77 Maverick & 71-77 Comet
C1AZ10A717A.....5.75

BATTERY DISCONNECT SWITCH



70-77 Maverick & 71-77 Comet
A14300C.....12.95

AUTOLITE STA-FUL BATTERY DECAL



70-72 Maverick & 71-72 Comet
DZ272.....5.00

BATTERY TEST OK DECAL



70-77 Maverick & 71-77 Comet
DF194.....4.00

AUTOLITE BATTERY TAG



70-72 Maverick & 71-72 Comet
DF784.....4.00

*****PRICES ARE SUBJECT TO CHANGE*****
 See disclaimer on front of catalog. Refer to website for
 current pricing. Confirm prices upon ordering.

AUTOLITE BATTERY POSITIVE TERMINAL TAG



70-72 Maverick & 71-72 Comet
DF1520.....6.50

BATTERY BOX RELOCATION KIT



- 13-1/2" Long X 9-1/2" Wide X 10" Hi - Not NHRA Legal
ENG658-039.....169.95

BATTERY TENDER



12V 1.25 AMP Battery Charger
BT-12V.....68.00



Brakes

BRAKE DRUM RETAINER



70-77 Maverick & 71-77 Comet
B13226...(6 pc).....3.50

FRONT BRAKE DRUM



70-75 Maverick & 71-75 Comet
BD2642...(70-71...9", 4 Lug).....65.00
BD1634...(71-73...10", 5 Lug).....60.00

REAR BRAKE DRUM



70-77 Maverick & 71-77 Comet
BD2641...(70-72...9", 4 Lug).....60.00
BD2623...(71-73...10", 5 Lug).....55.00
BD2667...(74-77...10", 5 Lug).....99.00

BRAKE SHOES



70-77 Maverick & 71-77 Comet
 - Professional Grade
 Front
R243...(70-72...w/9").....35.00
R154...(71...w/10").....35.00
R169...(72-75...w/10").....35.00
 Rear
R244...(70-72...w/9").....35.00
R151...(71-77...w/10").....35.00

SELF ADJUSTING KITS



70-75 Maverick & 71-75 Comet
H2514...(LH).....15.00
H2515...(RH).....13.00

BRAKE SHOE HARDWARE KIT



70-77 Maverick & 71-77 Comet
 Front
H7047...(70...9" x 2-1/4").....13.00
H7154...(71-72...9" x 2-1/4").....13.00
H7160...(73-75...9" or 10").....13.00
H7067...(71-75...10" x 2-1/4").....13.00
 Rear
H7048...(70...9" x 1-1/2").....13.00
H7161...(71-77...10" x 1-3/4").....13.00

PARKING BRAKE LEVER



70-77 Maverick & 71-77 Comet – All w/10" Brakes
C20A2A637A...(RH).....25.00
C20A2A638A...(LH).....25.00

PARKING BRAKE LEVER LOCK CLIP



70-77 Maverick & 71-77 Comet – REAR
91A2106...(ea).....1.00



Brakes

REAR BRAKE SPREADER BAR



70-72 Maverick & 71-72 Comet
T2A642...(9").....10.50
T2A643...(10").....10.50

REAR BRAKE SPREADER BAR SPRING



70-72 Maverick & 71-72 Comet
C0DD2601...(9" yellow).....5.00
 71-75 Maverick & Comet
C2OZ2601...(10" red).....3.00

PARKING BRAKE SPRING RETAINER



70-77 Maverick & 71-77 Comet
C4UZ2A787B...(for 10").....3.95

BRAKE ADJUSTMENT HOLE PLUG



70-77 Maverick & 71-77 Comet
PE108...(4 pc).....3.00



WHEEL CYLINDERS - FRONT DRUM



70-75 Maverick & 71-75 Comet
WC36100...(70...LH).....31.50
WC36101...(70...RH).....31.50
WC36017...(71...LH).....27.00
WC36018...(71...RH).....27.00
 72 with 170 or 200 six
WC37177...(LH).....27.00
WC37178...(RH).....27.00
 72 with 250 or 302
WC36017...(LH).....27.00
WC36018...(RH).....27.00
 73-75...All
WC36017...(LH).....27.00
WC36018...(RH).....27.00

WHEEL CYLINDERS - REAR DRUM



70-77 Maverick & 71-77 Comet
 70-72 with 170 or 200 six
WC37108...(LH or RH).....27.00
 71-72 with 250 or 302
WC36105...(LH).....30.00
WC36106...(RH).....30.00
 73...All
WC36105...(LH).....30.00
WC36106...(RH).....30.00
 74-75 with 7/8" bore
WC17507...(LH).....25.00
WC17508...(RH).....25.00
 76-77...All
WC370192...(LH).....30.00
WC370193...(RH).....30.00

BUSINESS HOURS
TUES-FRI 8:30-5:00
SATURDAY 8:30-2:00
CLOSED SUNDAY AND
MONDAY
EASTERN STANDARD TIME

Brakes

BRAKE SHOE TO CYLINDER LINK



70-77 Maverick & 71-77 Comet
Fits 70-75 front and 70-77 rear
B7A2042A...(2 required per wheel...ea).....4.25

BRAKE BLEEDER SCREWS



70-77 Maverick & 71-77 Comet
B10341...(pr)...(70-72 Wheel Cylinders).....3.50
B10342...(pr)...(74-77 Calipers).....3.50

DRUM BRAKE UPGRADE KIT



Rear-for 8" or 9" small bearing rear end. Get disc brake performance at a fraction of the cost with our 11" rear drum upgrade kit. This kit is for ford 8" & 9" small bearing rear ends. It uses 11" finned drums, high performance ceramic brake shoes & oversize wheel cylinders to greatly enhance performance over the orig. 9" or 10" drums-all components come pre-assembled on new backing plates so that all you have to do is remove the old drum compo. & install our new ones. The original parking brake cable will hook right up.

DR1504K.....575.00

BRAKE HUB



70-74 Maverick & 71-74 Comet w/5 Lug
C5ZZ1107.....75.00

WHEEL BEARING & RACE



70 Inner - Front - Before 8/25/69
A6...(ea).....15.00
70 Outer - Front - Before 8/25/69
A2...(ea).....15.00
70-77 Outer - Front - After 8/25/69
A12...(ea).....11.00
70-77 Inner - Front - After 8/25/69
A13...(ea).....13.00

INNER WHEEL BEARING GREASE SEAL



70-77 Maverick & 71-77 Comet
6815...(ea).....5.25

FRONT HUB GREASE CAP



70-77 Maverick & 71-77 Comet
B5A1131A...(ea).....4.50

REAR BRAKE BACKING PLATE HARDWARE



Fits 70-77 Maverick and 71-77 Comet
- For attaching backing plate to rear axle
AMK1440...(16 pc).....21.95

REAR AXLE SEAL



70-77 Maverick & 71-77 Comet
9569S...(ea).....10.95

AXLE BEARING & RACE



70-77 Maverick & 71-77 Comet
Outer - Rear w/7.25", 8", 9", 28 or 31 spline ring gear
RW207CCRA...(ea).....29.95

BUSINESS HOURS
TUES-FRI 8:30-5:00
SATURDAY 8:30-2:00
CLOSED SUNDAY AND
MONDAY
EASTERN STANDARD TIME

Brakes

DISC BRAKE ROTOR - FRONT



74-77 Mavericks & Comets
DR6042...(ea).....59.95

BRAKE CALIPERS



74-77 Maverick & Comet
FRC4069...(RH).....35.00
FRC4070...(LH).....35.00

DISC BRAKE PADS



74-77 Maverick & Comet
D91.....26.95

DISC BACKING PLATE GASKETS



74-77 Maverick & Comet
C8OZ2B160A...(pr).....3.95

DISC BRAKE - CONVERSION KIT (Special Order)



70-74 Maverick & 71-74 Comet
 Front-4 piston w/11" rotor-manual bolts to 6 cylinder or v8 drum brake spindles- This kit will convert front only to 5 x 4.5" bolt pattern -All hardware included- M/S will not bolt to stock booster on vehicles with power drum brakes- calipers includes stainless steel pistons, transfer tubes & bleeders- comes w/adjustable proportioning valve, hoses, lines, bearings, and seals. -Minimum wheel size 14" x 7"
A133-2.....1195.00

PARKING BRAKE PEDAL PAD



75-77 Maverick & Comet
C8SZ2454B.....5.00

PARKING BRAKE PEDAL PAD TRIM



75-77 Maverick & Comet
C8SZ2A798A.....9.00

BRAKE LINES - (Oversize S/H)

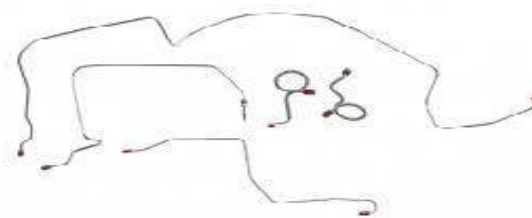

- Pre-bent, Appropriate fittings, Ready to Install

FRONT - (Oversize S/H)

- This kit includes all brake lines under the hood and to Pass. and Drivers side flex hose on front of vehicle.

1970 Maverick w/Drum Brakes
LKT7001...(4 pc).....75.00
LKT7001S...(4 pc stainless steel).....99.00

71-74 Maverick & Comet w/Drum Brakes
LKT7101...(5 pc).....69.00
LKT7101S...(5 pc stainless steel).....99.00

76-77 Maverick & Comet w/ Power Disc Brakes
LKT7601...(5 pc).....75.00
LKT7601S...(5 pc stainless steel).....105.00

76-77 Maverick & Comet w/ Disc Brakes – Non Power
LKT7602...(5 pc).....75.00
LKT7602S...(5 pc stainless steel).....105.00

***** PRICES ARE SUBJECT TO CHANGE*****

See disclaimer in front of catalog. Refer to website for current pricing. Confirm prices upon ordering.

Brakes

FRONT TO REAR BRAKE LINE - (**Upsize S/H**)

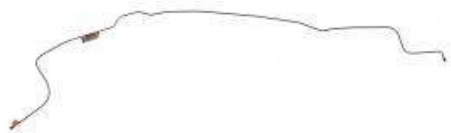

- Goes from proportioning valve along the length of vehicle to rear flex hose.

1970 Maverick	
LIN7001	59.00
LIN7001S...(stainless steel)	69.00
71 Maverick & Comet	
LIN7101	59.00
LIN7101S...(stainless steel)	69.00
1975 Maverick & Comet	
LIN7501	59.00
LIN7501S...(stainless steel)	69.00
76-77 Maverick & Comet	
LIN7601	59.00
LIN7601S...(stainless steel)	69.00

REAR AXLE BRAKE LINE - (**Upsize S/H**)



- This kit contains a pair of lines that run across the rear axle housing and connects to the rear flex hose.

1970 Maverick	
LRA7001	35.00
LRA7001S...(stainless steel)	45.00
71-74 Maverick & Comet	
LRA7101	35.00
LRA7101S...(stainless steel)	45.00

FRONT BRAKE - HYDRAULIC HOSE



70 Maverick - *These are correct for the 71-73 Mustang w/Front disc, but will work if used with a 3/8"-24 male to 7/16"-24 female adapter fitting.

Same bracket as OEM. Alternate for 70 w/Front Drum Brakes.	
H78073...(LH)	55.00
H78074...(RH)	55.00
71-73 Maverick & Comet (with front drum brakes)	
BH36549...(LH & RH)	25.00
74-75 Maverick & Comet (with front drum brakes)	
BH36744...(LH & RH)	25.00
74-77 Maverick & Comet (with front <u>disc</u> brakes)	
BH36649...(LH & RH)	25.00

REAR BRAKE CENTER - HYDRAULIC HOSE



70-71 Maverick & 71 Comet (w/170 6 cyl.)	
BH36659	39.95
71-77 Maverick & Comet (<u>except</u> 71 Maverick & Comet w/ 170 6 cyl.)	
BH36710	35.00

BRAKE CYLINDER BANJO BOLT



70 Maverick Only	
B12653	8.25

BRAKE LINE CLIP



70-77 Maverick & 71-77 Comet	
358360S...(70-71...brake line to frame rail...ea)	3.00
383368S...(70-77...brake & fuel vapor lines to firewall...pr)	4.00

BRAKE HOSE CLIP



70-77 Maverick & 71-77 Comet	
A7AZ2814A...(3 pc)	2.50

BRAKE LINE/SHOCK TOWER GROMMET



70-77 Maverick & 71-77 Comet	
- Used on shock tower where brake line passes through to engine compartment.	
B14604...(ea)	5.00



Brakes

POWER BRAKE BOOSTER SEAL



75-77 Maverick & Comet
C5ZZ2021.....9.95

BRAKE BOOSTER CHECK VALVE



70-77 Maverick & Comet
CV89021.....15.00
 74-77 Maverick & 74-77 Comet
C4AZ2365A.....15.00

BRAKE DISTRIBUTION BLOCK



74-77 Maverick & Comet
 w/ Disc/Drum Brakes
D0OZ2B257C.....105.00

DISTRIBUTION VALVE REBUILD KIT



70-77 Maverick & 71-77 Comet
2075-2...(70 Maverick w/Drum Brakes...before 7/14/69).....19.95
2075-4...(70-75 Maverick & 71-75 Comet w/Drum Brakes).....19.95
2075-5...(74-77 Maverick & Comet w/Disc Brakes).....49.95

ADJUSTABLE BRAKE VALVE w/BRAKE LIGHT SWITCH



70-77 Maverick & 71-77 Comet w/ Brake Modifications
A0730.....104.95

**VISIT US ON THE WEB AT:
WWW.MELVINSCLASSICFORDPARTS.COM**

ADJUSTABLE PROPORTIONING VALVE



70-77 Maverick & 71-77 Comet w/Brake Modifications
 - Adjustable, Black, Disc Brakes
C5ZZ2B091.....55.00

MASTER CYLINDER



70-77 Maverick & 71-77 Comet
MC39495...(70-73...w/drum brakes).....85.00
MC36248...(72 Comet...w/power brakes).....89.95
MC36440...(74-77...w/drum or manual disc brakes).....85.00
MC36445...(74-77...w/power disc brakes).....85.00

MASTER CYLINDER CAP GASKET



70-77 Maverick & 71-77 Comet
C7AZ2167A...(w/Disc Brakes).....4.50
C7AZ2167B...(w/Drum Brakes).....4.50

BRAKE PRESSURE DIFFERENTIAL VALVE WARNING LAMP SWITCH



70 Maverick before 7/14/69
C8AZ2B264A.....35.00
 73-77 Maverick & 75-77 Comet
D5AZ2B264A.....35.00

ADJUSTABLE BRAKE PUSH ROD



70-77 Maverick & 71-77 Comet – All w/Manual Brakes
A21161.....50.00

Brakes

MASTER CYLINDER BOOT



70-73 Maverick & 71-73 Comet
0A2180.....6.00

MASTER CYLINDER ROD BUSHING



70-77 Mavericks & 71-77 Comets
C9AZ2474A...(ea).....3.00

BRAKE SHAFT PEDAL BUSHING



70-77 Maverick & 71-77 Comet
B7AZ2471B...(ea...2 Req.).....1.00

PUSH ROD/STOP LIGHT SWITCH SPACER



71-72 Maverick & Comet (2-required)
C5DZ2B129B...(ea).....2.00

BRAKE LAMP SWITCH



70-77 Maverick & 71-75 Comet W/O Power Brakes
SW881.....18.00

BRAKE PEDAL SHAFT CLIP



70-77 Maverick & 71-77 Comet
380699S100.....3.00

PARKING BRAKE CABLES



70-77 Maverick & 71-77 Comet
 70 Maverick
REF101...(rear).....65.00
 71-72 Maverick & Comet
REF102...(rear - short).....60.00
REF120A...(rear - long).....65.00

PARKING BRAKE CABLE SEAL AT BACKING PLATE



70-77 Maverick & 71-77 Comet
AMK1791.....3.00

PARKING BRAKE CABLE CLIP



70-77 Maverick & 71-77 Comet
383475S100.....1.00



**VISIT US ON THE WEB AT:
WWW.MELVINSCLASSICFORDPARTS.COM**

Brakes

PARKING BRAKE CABLE CONNECTOR



70-74 Maverick & 71-74 Comet
C6OZ2A790A.....8.95

PARKING BRAKE CABLE EQUALIZER



70-77 Maverick & 71-77 Comet
C6OZ2A602A.....15.00

PARKING BRAKE CABLE IDLER



70-77 Maverick & 71-77 Comet
C7ZZ2A808A.....10.00

PARKING BRAKE EQUALIZER ROD



70-77 Maverick & 71-77 Comet
B7A2628B.....10.00

PARKING BRAKE PULLEY and CLEVIS PIN



71-75 Maverick & Comet
OM2804...(pulley).....19.95
9435...(pin).....1.25



UPS NEXT DAY & 2nd DAY AIR AVAILABLE

PARKING BRAKE RATCHET PAWL



70 Maverick (will fit 71-75 Maverick & Comet with modification)
OM2786.....12.00

PARKING BRAKE RATCHET PAWL SPRING



70 Maverick (Before 1/4/71)
OM2788R.....4.00

BRAKE PEDAL PAD



70-77 Maverick & 71-77 Comet
C6OZ2457A...(auto...drum).....9.00
D3ZZ2454A...(auto...disc).....12.50
C5ZZ2457G...(manual...drum).....5.00
C5ZZ2454D...(manual...disc).....10.00
C6OZ2457ABL...(billet...auto).....25.00

BRAKE PEDAL TRIM



70-77 Maverick & 71-77 Comet
C6OZ2A487A.....9.50
D1ZZ2A487B.....9.00

BUSINESS HOURS
TUES-FRI 8:30-5:00
SATURDAY 8:30-2:00
CLOSED SUNDAY AND
MONDAY
EASTERN STANDARD TIME

Clips / Retainers

MOLDING CLIP - WINDSHIELD



70-77 Maverick & 71-77 Comet
D0DZ6203174C...(replaces yellow clip)...(ea).....1.00
 Different look, same function as yellow clip
PE247...(20 pkg).....5.25

MOLDING CLIP - LDO BODY SIDE DOOR TRIM

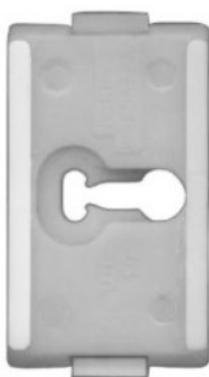

71-77 Maverick & Comet
 - Secures LDO trim to doors on 2 & 4 door models. Replaces Ford part # D1AZ7129192A. Different look, same function.
FA1306...(ea).....1.50

MOLDING CLIP - LDO BODY SIDE TRIM

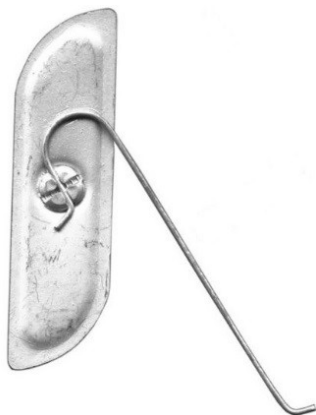

71-77 Maverick & Comet
 2-17/32" long, 10-24 x 3/4" stud
 - Secures LDO trim to vehicle on 2 & 4 door models. Replaces Ford part # C9AZ7142318A & D2DZ6229120A. Different look, same function.
19807...(ea).....1.50

MOLDING CLIP - FOR 5/8" BODY SIDE TRIM

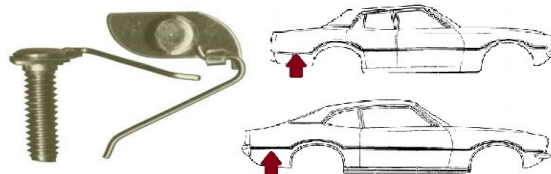

70-76 Maverick & 71-76 Comet
 - Secures 5/8" molding located on upper section of Comet and Mid-Section of Maverick. 2 & 4 door models. Replaces Ford part # D0OZ6520884A. 2744...(ea)......75

MOLDING CLIP - FOR 5/8" BODY SIDE TRIM



71-76 Maverick & Comet
 - Secures 5/8" molding located on upper section of Comet and Mid-Section of Maverick. 2 & 4 door models. Slightly different look than your original, same function. Replaces Ford part # D0OZ6620818A.
C7SZ6540248B...(ea).....2.00

MOLDING CLIP - FOR 5/8" BODY SIDE TRIM ENDS



70-76 Maverick & 71-76 Comet
 -Secures the ends of the 5/8" molding located on upper section of Comet and Mid-Section of Maverick. 2 & 4 door models. Replaces Ford part # D0OZ5425562A.
B13151...(clip - 3 pkg).....4.00
B12941...(8-32 nut - 4 pkg).....3.25

MOLDING CLIP - FOR BRIGHT TRIM



71-77 Maverick & Comet
 - Plastic Push-In. Secures end of Bright Trim on Top of doors behind mirror. No clip is reproduced which looks like your small original that accepts the screw. This clip is nylon and is designed to push into the hole used by the original screw. Modification and trimming will be necessary for this clip to work. Alternate replacement for Ford part # D2DZ6220884A.
8398...(ea)......75

Clips / Retainers

MOLDING CLIP - FOR BRIGHT TRIM



70-77 Maverick & 71-77 Comet
 - Secures bright trim on Top of door.
 Replaces Ford part # D2DZ6220818A.
D1MY6520818A...(ea).....1.00

MOLDING CLIP - FOR BRIGHT TRIM



71-77 Maverick & Comet
 - Secures bright trim on TOP of door above door handle and bright trim under quarter window. Replaces Ford part # C9AZ71423B & D2DZ5420884A. Nuts sold separately. Measures 1-7/16" long.
98-7816...(clip)...(ea).....1.00
B12955...(10-24 nut - pkg of 4).....4.25

MOLDING CLIP - UNIVERSAL

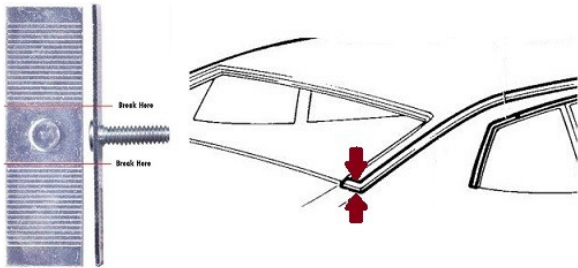

73-75 Maverick & Comet
 - Universal break off design. Can be used to replace the small square T-bolt clip if broken at red line shown in photo. Features a 10-24 thread x 3/4" stud. Makes a perfect replacement for Ford part # D3DZ6250002A.
19378...(ea).....1.00

MOLDING CLIP - VINYL TOP TRIM



73-75 Maverick & Comet
 - Secures vinyl top trim to roof sides
FA321...(ea).....1.50

MOLDING CLIP - VINYL TOP TRIM



76-77 Maverick & Comet
 - Secures vinyl top trim to roof back
11344...(ea).....1.50

MOLDING CLIP - ROCKER PANEL ENDS



70-77 Maverick & 71-77 Comet
 - Can be used to secure ends of rocker panel molding. It is little longer than your original and will require a small amount of trimming. A great alternate replacement for Ford part # D0DZ6210182A. This clip measures 1.766" x 1.396".
1056...(ea).....2.00

MOLDING CLIP - BODY SIDE TRIM



71-77 Maverick & Comet
 - Secures body side molding to vehicle above rear wheel openings. Replaces Ford part # D0DZ6229120A.
78-4895...(ea).....2.00

A/C & HEATER BOX CLIP



70-77 Maverick & 71-77 Comet
C0DF19A779A...(ea).....2.50

***** PRICES ARE SUBJECT TO CHANGE*****
 See disclaimer in front of catalog. Refer to website for current pricing. Confirm prices upon ordering.

Clips / Retainers

ANTENNA CABLE CLIP



- Used to secure antenna cable under dash
376118S... (ea).....1.95

ARMREST CLIP



70-73 Maverick & 71-73 Comet w/o Molded Armrest
C6AZ6224146EA... (ea).....2.00
C6AZ6224146B... (6 pkg).....9.95

BRAKE HOSE CLIP



70-77 Maverick & 71-77 Comet
A7AZ2814A... (3 pkg).....2.50

BRAKE PEDAL SHAFT SPRING CLIP



70-77 Maverick & 71-77 Comet
380699S100.....3.00

BRAKE LINE CLIP



70-77 Maverick & 71-77 Comet
358360S... (70-71)... (ea)... (brake line to frame rail).....3.00
383368S... (70-77)... (pr)... (brake & fuel vapor lines to firewall)...4.00

PARKING BRAKE LEVER LOCK CLIP



70-77 Maverick & 71-77 Comet - REAR
91A2106... (ea).....1.00

PARKING BRAKE CABLE CLIP



70-77 Maverick & 71-77 Comet
383475S100... (ea).....1.00

CLUTCH EQUALIZER BAR BALL CLIP



C1DD7A626A... (70-77 6 cyl).....2.00
97474S... (71-77 w/302).....2.50
C5AZ7B545A... (71-77 w/302).....3.00

CLUTCH & TRANSMISSION LINKAGE ROD CLIP



70-77 Maverick & 71-77 Comet
352358S... (ea)......79

TRANSMISSION OIL COOLER LINE CLIPS



70-77 Maverick & 71-77 Comet
C5ZZ7A032... (pr).....5.95

DOOR LATCH ROD RETAINER CLIP



70-77 Maverick & 71-77 Comet
C5AZ6221952AR... (ea).....5.50

DOOR PANEL CLIPS



70-77 Maverick & 71-77 Comet
PE150... (15 pkg).....3.50

Clips / Retainers

GRILLE CLIP



70-77 Maverick & 71-77 Comet
 - Used to secure top of grille to vehicle.
 only two (2) required. Black Nylon
AMK139...(5 pkg).....3.95

WIPER ARM LINKAGE CLIP



70-77 Maverick & 71-77 Comet
C5ZZ17531A...(ea).....3.00

HOOD PROP ROD CLIP



76-77 Maverick & Comet
 - Secures hood prop rod to fender apron
386299S.....3.00

HOOD PROP ROD RETAINER



76-77 Maverick & Comet
 - Attaches hood prop rod to vehicle
D5ZZ16828A.....4.00

A/C COMPRESSOR TAG RETAINER



70-77 Maverick & 71-77 Comet
13881...(ea).....4.00

BARREL NUT - SCRIPT RETAINER



70-77 Maverick & 71-77 Comet
 2-Door Models scripts has 1/8" stud
 4-Door Models scripts has 3/32" stud, same used for all hood/trunk letters
B12925...(for 1/8" stud, 2 door models...8 pkg).....3.25
B12924...(for 3/32" stud, 4 door models...8 pkg).....3.50

BRAKE DRUM RETAINER



70-77 Maverick & 71-77 Comet
B13226...(6 pkg).....3.50

BRAKE SHOE LINK SPRING RETAINER



72-77 Maverick & Comet w/10" Brake Shoes
C4UZ2A787B...(ea).....3.95

DOOR GLASS RETAINER



70-77 Maverick & 71-77 Comet
 - Secures door glass to window channel
D1FZ62234A46A...(ea).....6.00

DOOR & TRUNK LOCK RETAINER



70-77 Maverick & 71-77 Comet
 - Used on trunk lock until 3/1/72
C5AZ6222023A...(ea).....3.00



**Melvin's Classic
 Ford Parts
 PHONE: 770-761-6800**

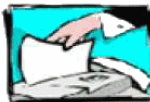

Clips / Retainers

FIREWALL PAD RETAINER



70-77 Maverick & 71-77 Comet
C8ZZ6501691A... (ea).....1.50

HEADLINER ROD RETAINERS



70-77 Maverick & 71-77 Comet (2-door only)
 - Attaches to roof and holds the rear headliner rod in place
C5ZZ6342180... (pr).....9.95

SEAT ADJUSTING KNOB RETAINER



70-77 Maverick & 71-77 Comet
C5AZ626060A... (ea).....3.50

SPEEDOMETER CABLE GEAR RETAINER



70-77 Maverick & 71-77 Comet
 - All Transmissions
C1DZ17292A.....3.00

SPEEDOMETER CABLE RETAINER



70-77 Maverick & 71-77 Comet
 - Secures cable at Transmission crossmember
373829.....3.95

WEATHERSTRIP RETAINER



70-77 Maverick & 71-77 Comet
 - Secures Radiator Support Seal to top of Radiator Support.
 - Also used to secure the ends of the roofrail weatherstrip.
FA3832... (ea)..... .75

WEATHERSTRIP RETAINER



70-77 Maverick & 71-77 Comet
 - Secures roofrail weatherstrip to vehicle.
B10766... (10 pkg).....3.50

WIRE LOOM RETAINER



70-77 Maverick & 71-77 Comet
 - Used on various wiring looms
C7AZ13A50.....2.25

WIRING RETAINER

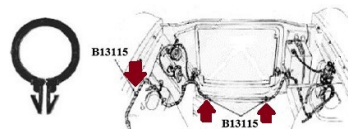

70-77 Maverick & 71-77 Comet
 - Secures wire loom to top of shock tower, lower radiator support and wiring next to voltage regulator on fender apron.
B13115... (4 pkg).....3.25

WIRING RETAINER



70-77 Maverick & 71-77 Comet
 - Secures front marker light wiring harness to front of radiator support
B13113... (4 pkg).....3.25

WIRING RETAINER



70-77 Maverick & 71-77 Comet
 - Secures Headlamp wiring harness to front of radiator support and wiring next to starter solenoid on fender apron.
B13117... (4 pkg).....3.25

**VISIT US ON THE WEB AT:
WWW.MELVINSCCLASSICFORDPARTS.COM**

Clutch

CLUTCH KIT



70-77 Maverick & 71-77 Comet
C7ZZ7563-6...(170-200 6 cyl...9").....**239.95**
C5ZZ7563ZK...(250-302 10").....**189.95**

CLUTCH PRESSURE PLATE BOLTS



70-77 Maverick & 71-77 Comet
ARP150-2201.....**14.95**

FLYWHEEL



70-77 Maverick & 71-77 Comet
 - 157 teeth
C3AZ6375J...(302).....**199.00**

FLYWHEEL RING GEAR

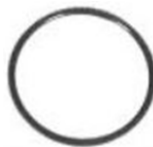

70-77 Maverick & 71-77 Comet w/250 or 302
C2OZ6384B...(250 & 302 - 157 Teeth).....**30.00**

FLYWHEEL/FLEXPATE BOLTS



AMK1839 x6

AMK1840 x6

70-77 Maverick & 71-77 Comet
AMK1839...(7/16"-20 x 15/16" - w/ manual trans.).....**15.75**
AMK1839...(7/16"-20 x 15/16" - C4 w/reinforcement ring).....**15.75**
AMK1840...(7/16"-20 x 3/4" - C4 w/o reinforcement ring).....**15.75**

BELLOUSING/ENGINE SPACER PLATE



71-77 Maverick & Comet – Manual Trans w/250 or 302
C5DZ7007A.....**45.00**

PILOT BEARING



70-77 Maverick & 71-77 Comet
FC65662.....**15.75**

CLUTCH RELEASE BEARING



70-77 & 71-77 Comet
FB1625C.....**38.00**

CLUTCH FORK



70-77 Maverick & 71-77 Comet w/250 or 302
 - Correct for many other Fords, but closest to the original
C8OZ7515A...(250-302).....**65.00**

CLUTCH RELEASE LEVER BRACKET



70-77 Maverick & 71-77 Comet
C8OZ7522A...(170-200).....**25.00**
C8AZ7522B...(250-302).....**22.00**



**Melvin's Classic
 Ford Parts
 PHONE: 770-761-6800**



Clutch

CLUTCH RELEASE LEVER DUST BOOT



70 -72 Maverick & 71-72 Comet
C6OZ7513C...(all).....15.75
 73-77 Maverick & Comet
C6GY7513A...(6 cyl only).....15.75

CLUTCH ROD



70-77 Maverick & 71-77 Comet
 - Adjustable, 8-1/4"
C7OZ7521A...(6 cyl & V8).....24.50

CLUTCH RELEASE LEVER SPRING



Fork to Equalizer Bar
 70-77 Maverick & 71-77 Comet
 - Correct for 69 Mustang, but closest to the original
C9ZZ7591A.....12.95

CLUTCH RELEASE ROD BUSHING



70-77 Maverick & 71-77 Comet V8 or 6 Cyl.
C0AZ7526B...(2 required...ea).....2.00

CLUTCH ROD RETAINER SPRING



Equalizer Bar to Firewall
 70-77 Maverick & 71-77 Comet
 - Correct for 67 Mustang, but closest to the original
C7ZZ7523AR.....15.00

**VISIT US ON THE WEB AT:
WWW.MELVINSCCLASSICFORDPARTS.COM**

CLUTCH LINKAGE ROD RETAINING CLIP



70-77 Maverick & 71-77 Comet
352358S...(ea)..... .79

CLUTCH RELEASE LEVER IDLER SWIVEL



70-75 Maverick & 71-75 Comet
D1DZ7A528E...(non-threaded).....14.95
D1DZ7A528T...(threaded).....14.95

CLUTCH PEDAL ROD AT FIREWALL SEAL



70-77 Maverick & 71-77 Comet
C6OZ7A533.....7.50

CLUTCH EQUALIZER BAR ENGINE SIDE MOUNT



70-77 Maverick & 71-77 Comet
 - All w/added Later model 5.0 engines.
 Will not work with reproduction Equalizer Bar.
TRA658-538.....75.00

CLUTCH EQUALIZER BAR - FRAME MOUNT BRACKET



70-77 Maverick & 71-77 Comet
C5ZZ7507A...(6 cyl).....18.00

CLUTCH PIVOT DUST GROMMET

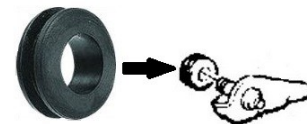

71-76 Maverick & Comet w/302
4428...(V8)..... .95

Clutch

CLUTCH EQUALIZER BAR - ENGINE SIDE MOUNT



70-77 Maverick & 71-77 Comet
C20A7A531B...(6 cyl).....15.00

CLUTCH EQUALIZER BAR SHAFT BALL



70-77 Maverick & 71-77
C1AA7543A...(6 cyl...ea).....5.00

71-77 Maverick & 71-77
CODD7517A...(302...pr).....15.00

CLUTCH EQUALIZER BAR BUSHING KIT



1971-1977 Maverick & 71-77 Comet 302
D1ZZ7543KIT.....35.00

CLUTCH EQUALIZER BAR REPAIR KIT



70-77 Maverick & 71-77 Comet - all 6 cyl
C1DD7543KIT.....18.00

CLUTCH EQUALIZER BAR BALL CLIP



C1DD7A626A...(70-77 6 cyl).....2.00
97474S...(71-77 w/302).....2.50
C5AZ7B545A...(71-77 w/302).....3.00

CLUTCH PEDAL SHAFT BUSHING



70-77 Maverick & 71-77 Comet
B7AZ2471B...(2 req...ea).....1.00

CLUTCH PEDAL SUPPORT REPAIR KIT



70-77 Maverick & 71-77 Comet
378200K.....18.95

CLUTCH LEVER SHAFT REPAIR KIT



70-77 Maverick & 71-77 Comet
C5ZZ2478AK.....15.00

CLUTCH PEDAL ROLLER BEARING KIT



70-77 Maverick & 71-77 Comet
C5ZZ2478RBMK.....49.95



Clutch

CLUTCH PEDAL BUMPER



70-77 Maverick & 71-77 Comet
C8OZ7583A.....10.00

CLUTCH PEDAL RETURN SPRING



70-77 Maverick & 71-77 Comet
C8OZ7534B.....29.95

SHIFT LINKAGE REPAIR KIT



70-77 Maverick & 71-77 Comet
C5ZZ7285RPK2.....20.00

CONVERSION SPACER PLATE - ADAPTER KIT



71-77 Maverick & Comet
 T-5 Conversion Component
TRA650-526.....160.00

FULCRUM SPACER BLOCK KIT



71-77 Maverick & Comet
 T-5 Conversion Component
TRA670-524.....45.00

***** PRICES ARE SUBJECT TO CHANGE*****
 See disclaimer in front of catalog. Refer to website for
 current pricing. Confirm prices upon ordering.

CLUTCH PEDAL PAD



70-77 Maverick & 71-77 Comet
C5ZZ7A624B.....3.75

CLUTCH PEDAL PAD TRIM



70-77 Maverick & 71-77 Comet
C5ZZ7B544.....7.75



Console / Shifter

CONSOLETTA HINGE/DOOR HARDWARE

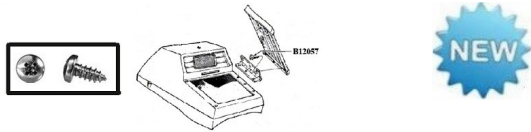

Secures door to hinge
 70-73 Maverick & 71-73 Comet
B12057-3...(set of 3).....1.00

CONSOLETTA DOOR RUBBER BUMPERS

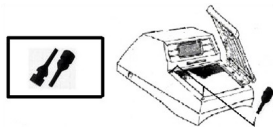

All Mavericks and Comets with a factory consolette
 - Used to cushion door upon closing.
 - Not factory correct but work very nicely
PE251...(pr).....2.00

CONSOLETTA CLOCK – POWER FEED HARNESS PIGTAIL



70-73 Maverick & 71-73 Comet
8769.....2.99

CONSOLETTA LATCH/LOCK



70-73 Maverick & 71-73 Comet
C9ZZ6506072A...(non-locking).....20.00
C9ZZ6506072AL...(locking w/keys).....25.00
C9ZZ6506072K...(locking w/keyed alike trunk lock).....35.00

AUTOMATIC TRANSMISSION SHIFTER COVER



71-76 Maverick & Comet w/ floor shift
C9ZZ7D394A...(71-74).....69.50
D5FZ7D443B...(75-76).....CALL

SHIFT COVER HARDWARE



71-74 Maverick & Comet w/ floor shift
AMK1235...(4 pkg).....3.00

AUTO FLOOR SHIFT INDICATOR LIGHT SHIELD

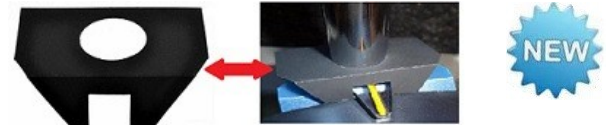

71-76 Maverick & Comet
C9ZZ7E130A.....18.95

AUTO FLOOR SHIFT LIGHT DIFFUSER



71-76 Maverick & Comet
 *lighter shade of blue than original
C9ZZ15811R.....18.95

AUTO SHIFTER HOUSING TO FLOOR SEAL



71-74 Maverick & Comet w/Auto Floor Shift
C9ZZ7370.....4.25



Console / Shifter

**AUTO TRANSMISSION SELECTOR
DIAL RUBBER SEAL**



71-74 Maverick & Comet w/ Auto Floor Shift
D1ZZ7D351A.....10.50

SHIFT LEVER CABLE - AUTO



71-76 Maverick & Comet w/Floor Shift
C5ZZ7D246A.....23.50

AUTO SHIFT HOUSING BOLT PLUG



71-76 Maverick & Comet w/ Auto Floor Shift
C7ZZ7C147A.....3.00

**AUTOMATIC TRANSMISSION
FLOOR SHIFT KNOB**



71-76 Maverick & Comet
C9OZ7213B...(chrome).....26.95
C8OZ7213BKL...(black).....65.00
C8OZ7213MR...(maroon).....65.00
C8OZ7213BL...(blue).....65.00
C8OZ7213SA...(saddle/ginger).....65.00
C8OZ7213PR...(parchment).....65.00



**AUTOMATIC TRANSMISSION FLOOR SHIFT KNOB
SET SCREW**



PE587..... 0.75

AUTO SHIFTER KNOB BUTTON



C9ZZ7C488C.....8.00

AUTO SHIFTER KNOB BUTTON



Left Hand - Chrome
C8OZ7C488A.....25.00

AUTO SHIFTER KNOB BUTTON



Right Hand-Stationary Button-Black
C5ZZ7C488D.....3.00



***** PRICES ARE SUBJECT TO CHANGE*****
See disclaimer in front of catalog. Refer to website for
current pricing. Confirm prices upon ordering.

Console / Shifter

AUTO SHIFT LEVER RELEASE LOCKOUT SPRING



70-76 Maverick & 71-76 Comet w/Auto Floor Shift
C5ZZ7C300A.....**6.00**

SHIFTER INDICATOR



71-76 Maverick & Comet
 - Used on Auto Floor Shifter
C9ZZ7A110A.....**10.00**

AUTOMATIC COLUMN SHIFT KNOB



70-76 Maverick & 71-76 Comet
D3OZ7213A...(chrome metal).....**19.95**
 73-77 Maverick & Comet
E3SZ7213A...(black plastic).....**10.00**

GEAR SHIFT COLLAR POINTER



70-77 Maverick & 71-77 Comet
C8AZ7A110A.....**16.85**

SHIFT SELECTOR LENS - COLUMN MOUNTED



70 Maverick - w/Non-Locking Column ONLY
C8SZ7B037A.....**20.00**

MANUAL FLOOR SHIFT KNOB



3 Speed - Black
C8OZ7213B.....**18.00**

GEAR SHIFT LEVER BOOT - ALTERNATIVE



This boot is correct for the 69-70 Mustang. It is currently the closest reproduction on the market to replace your damaged factory shift boot.
C9ZZ7277A.....**20.00**

MANUAL SHIFT LEVER INSULATOR



70-77 Maverick & 71-77 Comet
 - All requiring an insulator, cut as required
01A7246B.....**9.95**



BUSINESS HOURS
TUES-FRI 8:30-5:00
SATURDAY 8:30-2:00
CLOSED SUNDAY AND
MONDAY
EASTERN STANDARD TIME

Dash

DASH PAD COVER/CAP - (**Oversize S/H**)



70-77 Maverick & 71-77 Comet
- Black Only, Can be painted to match

DASH405.....119.95

DASH PAD HARDWARE



- End of Dash Pad to Dash Board

B11843...(pr).....2.00

DASH PAD HARDWARE



- Dash Pad to Dash

B11492...(12 pkg).....8.50

INSTRUMENT BEZEL LENS



70-77 Maverick & 71-77 Comet

Note, This lens set is for a 69-70 Mustang, the center piece is all you will need for your application

C9ZZ10887A.....42.00

INSTRUMENT GAUGE INSULATOR



70-77 Maverick & 71-77 Comet

C9ZZ10C914A.....5.00

SPEEDOMETER HEAD GASKET



70-77 Maverick & 71-77 Comet

C9MY17303A.....5.00

VISIT US ON THE WEB AT:
WWW.MELVINSCLASSICFORDPARTS.COM

INSTRUMENT PANEL LIGHT SOCKET



70-77 Maverick & 71-77 Comet

12237.....3.00

GLOVE BOX LINERS



74-77 Maverick & Comet

FAM-063...(w/o AC).....20.00

FAM-064...(w/ AC).....20.00

GLOVE BOX BUMPERS



73-77 Maverick & Comet

PE120...(pr).....1.50

ASH TRAY BUMPER



70-77 Maverick & 71-77 Comet

358159A2S...(ea).....3.00

CIGARETTE LIGHTER ASSEMBLY



70-77 Maverick & 71-77 Comet

C7ZZ15052K...(lighter & well).....21.95

CIGARETTE LIGHTER



70-77 Maverick & 71-77 Comet

C7ZZ15052A...(lighter only).....20.00

Dash

HEATER CONTROL KNOBS



70-77 Maverick & 71-77 Comet
 - These are for 69-70 Mustangs, but look and work great!
 Comes as a set of 3, you will need to order 2 kits if your application
 has a rear window defogger to obtain the additional knob
C9ZZ18519A...(3 pkg).....16.85

SPORTLAMP TOGGLE SWITCH KNOB



71-72 Maverick
41876-A.....9.95

IGNITION SWITCH BEZEL



- 70 Maverick Only W/O Locking Column
C9ZZ11584.....24.00

MATCHING DASH KNOBS - OPTION



70-77 Maverick and 71-77 Comet
 - These knobs are correct for the 65 Mustang. The knobs are chromed
 metal. The wiper knob installs using a set screw and can be applied to
 the wiper switch shaft as well as the radio stems. The wiper knob also
 matches the Headlight stem knob. Order 3 for wiper/radio.
C4AZ17513A...(ea).....8.50

HEADLIGHT STEM w/ATTACHED KNOB



- see above description
C5ZZ11661B.....11.00



**Melvin's Classic
 Ford Parts
 PHONE: 770-761-6800**



WINDSHIELD WIPER KNOB – OPTIONS



70-77 Maverick & 71-77 Comet
D3OZ17513B...(chrome plastic, octagon shape).....12.95
E5TZ17513A...(black plastic, octagon shape).....25.00
D3OZ17513...(chrome plastic, octagon shape).....25.00
C4AZ17513A...(see left column).....8.50

REAR WINDOW DEFOGGER SWITCH KNOB



73-77 Maverick & Comet
 *correct replacement for Dealer installed Rear Window Defogger Switch
C8UZ17513A...(ea).....15.00

RADIO KNOBS



73-74 Maverick & Comet
D1ZZ18817...(4 pc).....50.00
 75-77 Maverick & Comet
D3AZ18817A...(ea).....6.00

IN DASH 5" x 7" SPEAKER



70-77 Maverick & 71-77 Comet
 - Minor Modification may be necessary -
SPEAKER3.....20.00
 Aftermarket 30 Watt, 3" Dual Cone in Dash Speaker,
 - 5" x 7"
SPEAKER4.....35.00

**BUSINESS HOURS
 TUES-FRI 8:30-5:00
 SATURDAY 8:30-2:00
 CLOSED SUNDAY AND
 MONDAY
 EASTERN STANDARD TIME**

Decals

AIR CLEANER DECALS - MAVERICK

6 Cylinder Models



70-71 Maverick	
DF941...(120 HP).....	4.50
71 Maverick	
DF560...(200).....	4.50
72 Maverick	
DL767...(250).....	5.00
72-73 Maverick	
DF854...(200).....	4.50
73-75 Maverick	
DF643...(250).....	4.50
74 Maverick	
DF1457...(250).....	4.50

V-8 (302) Models



71 Maverick	
DF182...(302-2/V Reg. Fuel).....	4.50
72 Maverick	
DF253...(302-2/V Reg. Fuel).....	4.50
73 Maverick	
DF584...(302-2/V Reg. Fuel).....	4.50



74-75 Maverick	
DF480...(302-2/V Reg. Fuel).....	4.50
76-77 Maverick	
DF716...(302-2/V Unleaded Fuel).....	4.50

**VISIT US ON THE WEB AT:
WWW.MELVINSCLASSICFORDPARTS.COM**

AIR CLEANER DECALS - COMET

6 Cylinder Models



71 Comet	
DL740...(200).....	5.00
71 Comet	
DL688...(250).....	5.00
72 & 73 Comet	
DL810...(200).....	5.00
72 Comet	
DL767...(250).....	5.00
73 Comet	
DL273...(250).....	5.00
74-75 Comet	
DF643...(250).....	4.50

V-8 (302) Models



71 Comet	
DL321...(silver).....	4.50
DL301...(gold).....	5.00



72 Comet	
DL211...(302-2/V Reg. Fuel).....	5.00
73 Comet	
DL775...(302-2/V Reg. Fuel).....	5.00



74 Comet	
DL276...(302-2/V Reg. Fuel).....	5.00
75-77 Comet	
DL327...(302-2/V Unleaded Fuel).....	5.00

AIR CLEANER "FRONT" DECAL



70-75 Maverick & 71-75 Comet	
DF150.....	3.50

Decals

AUTOLITE REPLACEMENT PARTS AIR CLEANER DECAL



70-72 Maverick & 71-72 Comet
DF0325.....5.00

FORD AUTOLITE DECAL



70-72 Maverick & 71-72 Comet
DZ120...(ea).....5.00

A/C CHARGE DECALS



71 Maverick & Comet
DF435...(blue).....5.00
DF1504...(black).....5.00

72-73 Maverick & Comet
DF551...(red).....4.50

74-77 Maverick & Comet
DF697...(orange).....5.00

BATTERY TEST OK DECAL



70-77 Maverick & 71-77 Comet.
DF194.....4.00

AUTOLITE STA-FUL BATTERY DECAL



70-72 Maverick & 71-72 Comet
DZ0272.....5.00

AUTOLITE BATTERY TAG



70-72 Maverick & 71-72 Comet
DF784.....4.00

AUTOLITE BATTERY POSITIVE TERMINAL TAG



Fits 70-72 Maverick & 71-72 Comet
DF1520.....6.50

CAUTION FAN DECAL



70-77 Maverick & 71-77 Comet
DF31.....4.00

COIL DECALS



70-72 Maverick & 71-72 Comet
DF224.....5.00

72-77 Maverick & Comet
DF715.....5.00

COOLANT CAUTION DECAL



76 Maverick & Comet
DF0654.....4.50

77 Maverick & Comet
DF828.....4.50

DURASPARK MODULE DECAL



75-77 Maverick & Comet
DF425.....5.00

VOLTAGE REGULATOR DECALS



70-72 Maverick & 71-72 Comet
DF348...(yellow).....5.00

72-77 Maverick & Comet
DF714...(black).....5.00

Decals

GLOVE BOX MAINTENANCE SCHEDULE B DECAL



76-77 Maverick & Comet
DF1287.....4.50

SERVICE SPECIFICATION DECAL

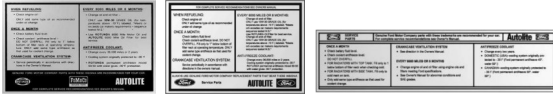

70 - (Early)
DF0052.....4.00
 70 - (Late)
DF346.....4.00
 71 Maverick & Comet
DF308.....4.00

EMISSION DECALS

70 Maverick



DF1375...(w/170, before 10/1/69).....6.00
DF1377...(w/200, before 10/1/69).....5.00
DF772...(w/200, between 10/1/69-1/1/70).....5.00
DF1366...(w/250, before 10/1/69).....5.00
DF1352...(w/250, After 10/1/69).....5.00

71 Maverick & Comet

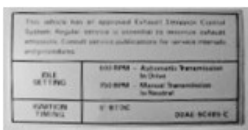

Maverick
DF666...(w/200).....5.00
 Comet
DL347...(w/200).....5.00
 Maverick
DF1238...(w/302).....4.00
 Comet
DL714...(w/302, AT).....5.00
 Comet
DL345...(w/302).....5.00

72 Maverick & Comet



Maverick & Comet
DF1669...(w/250).....5.00
 Maverick
DF843...(w/302).....5.00
 Comet
DL475...(w/302).....5.00

74 Maverick & Comet



Maverick & Comet
DF1503...(w/302).....5.00

76 Maverick & Comet



Maverick
DF302...(w/302, MT).....6.00
 Maverick
DF301...(w/302, AT).....6.00
 Comet
DL456...(w/302, AT).....6.00
 Comet
DL455...(w/302, MT).....6.00

VEHICLE EMISSION CONFORMING DECAL



76 Maverick & Comet
DF366.....5.00

EMISSION CONTROL DECAL

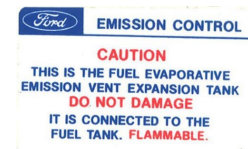

DF954...(70 Maverick w/California Emissions).....5.00

Decals

COMET TIRE PRESSURE DECALS

COMET		RECOMMENDED TIRE SIZE and INFLATION PRESSURE (PSI)			
MODEL	YEAR	FRONT	REAR	FRONT	REAR
71	1971	155R13	155R13	24	24
72	1972	155R13	155R13	24	24
73	1973	155R13	155R13	24	24
74	1974	155R13	155R13	24	24
75	1975	155R13	155R13	24	24
76	1976	155R13	155R13	24	24
77	1977	155R13	155R13	24	24
78	1978	155R13	155R13	24	24
79	1979	155R13	155R13	24	24
80	1980	155R13	155R13	24	24
81	1981	155R13	155R13	24	24
82	1982	155R13	155R13	24	24
83	1983	155R13	155R13	24	24
84	1984	155R13	155R13	24	24
85	1985	155R13	155R13	24	24
86	1986	155R13	155R13	24	24
87	1987	155R13	155R13	24	24
88	1988	155R13	155R13	24	24
89	1989	155R13	155R13	24	24
90	1990	155R13	155R13	24	24
91	1991	155R13	155R13	24	24
92	1992	155R13	155R13	24	24
93	1993	155R13	155R13	24	24
94	1994	155R13	155R13	24	24
95	1995	155R13	155R13	24	24
96	1996	155R13	155R13	24	24
97	1997	155R13	155R13	24	24
98	1998	155R13	155R13	24	24
99	1999	155R13	155R13	24	24
00	2000	155R13	155R13	24	24
01	2001	155R13	155R13	24	24
02	2002	155R13	155R13	24	24
03	2003	155R13	155R13	24	24
04	2004	155R13	155R13	24	24
05	2005	155R13	155R13	24	24
06	2006	155R13	155R13	24	24
07	2007	155R13	155R13	24	24
08	2008	155R13	155R13	24	24
09	2009	155R13	155R13	24	24
10	2010	155R13	155R13	24	24
11	2011	155R13	155R13	24	24
12	2012	155R13	155R13	24	24
13	2013	155R13	155R13	24	24
14	2014	155R13	155R13	24	24
15	2015	155R13	155R13	24	24
16	2016	155R13	155R13	24	24
17	2017	155R13	155R13	24	24
18	2018	155R13	155R13	24	24
19	2019	155R13	155R13	24	24
20	2020	155R13	155R13	24	24
21	2021	155R13	155R13	24	24
22	2022	155R13	155R13	24	24
23	2023	155R13	155R13	24	24
24	2024	155R13	155R13	24	24
25	2025	155R13	155R13	24	24
26	2026	155R13	155R13	24	24
27	2027	155R13	155R13	24	24
28	2028	155R13	155R13	24	24
29	2029	155R13	155R13	24	24
30	2030	155R13	155R13	24	24

- 71 Comet
DL916.....6.00
- 72 Comet (Early)
DL917...(before 7/1/72).....6.00
- 72 Comet (Late)
DL918...(after 7/1/72).....6.00
- 73 Comet
DL919.....6.00
- 74 Comet
DL920.....6.00
- 75 Comet
DL921.....6.00
- 76 Comet
DL922.....6.00
- 77 Comet
DL923.....6.00

MAVERICK TIRE PRESSURE DECALS

MAVERICK		RECOMMENDED TIRE SIZE and INFLATION PRESSURE (PSI)			
MODEL	YEAR	FRONT	REAR	FRONT	REAR
70	1970	155R13	155R13	24	24
71	1971	155R13	155R13	24	24
72	1972	155R13	155R13	24	24
73	1973	155R13	155R13	24	24
74	1974	155R13	155R13	24	24
75	1975	155R13	155R13	24	24
76	1976	155R13	155R13	24	24
77	1977	155R13	155R13	24	24
78	1978	155R13	155R13	24	24
79	1979	155R13	155R13	24	24
80	1980	155R13	155R13	24	24
81	1981	155R13	155R13	24	24
82	1982	155R13	155R13	24	24
83	1983	155R13	155R13	24	24
84	1984	155R13	155R13	24	24
85	1985	155R13	155R13	24	24
86	1986	155R13	155R13	24	24
87	1987	155R13	155R13	24	24
88	1988	155R13	155R13	24	24
89	1989	155R13	155R13	24	24
90	1990	155R13	155R13	24	24
91	1991	155R13	155R13	24	24
92	1992	155R13	155R13	24	24
93	1993	155R13	155R13	24	24
94	1994	155R13	155R13	24	24
95	1995	155R13	155R13	24	24
96	1996	155R13	155R13	24	24
97	1997	155R13	155R13	24	24
98	1998	155R13	155R13	24	24
99	1999	155R13	155R13	24	24
00	2000	155R13	155R13	24	24
01	2001	155R13	155R13	24	24
02	2002	155R13	155R13	24	24
03	2003	155R13	155R13	24	24
04	2004	155R13	155R13	24	24
05	2005	155R13	155R13	24	24
06	2006	155R13	155R13	24	24
07	2007	155R13	155R13	24	24
08	2008	155R13	155R13	24	24
09	2009	155R13	155R13	24	24
10	2010	155R13	155R13	24	24
11	2011	155R13	155R13	24	24
12	2012	155R13	155R13	24	24
13	2013	155R13	155R13	24	24
14	2014	155R13	155R13	24	24
15	2015	155R13	155R13	24	24
16	2016	155R13	155R13	24	24
17	2017	155R13	155R13	24	24
18	2018	155R13	155R13	24	24
19	2019	155R13	155R13	24	24
20	2020	155R13	155R13	24	24
21	2021	155R13	155R13	24	24
22	2022	155R13	155R13	24	24
23	2023	155R13	155R13	24	24
24	2024	155R13	155R13	24	24
25	2025	155R13	155R13	24	24
26	2026	155R13	155R13	24	24
27	2027	155R13	155R13	24	24
28	2028	155R13	155R13	24	24
29	2029	155R13	155R13	24	24
30	2030	155R13	155R13	24	24

- 1970 (Early)
DF1235.....6.00
- 1970 (Late)
DF1349.....6.00
- 72 - Maverick
DF1245.....6.00
- 73 - Maverick
DF949.....6.00
- 74 - Maverick
DF1667.....6.00
- 77 - Maverick
DF1506.....6.00

SEATBELT WINDOW DECAL



- 75-77 Maverick & Comet
DF879...(ea).....4.50

TRUNK - JACK INSTRUCTIONS



- 70 Maverick
DF943.....4.50
- 71-72 Maverick & Comet
DF544.....4.50
- 73-76 Maverick & Comet
DF1213.....4.50
- 77 Maverick & Comet
DF962.....4.50

POWERED BY 302 DECALS



AFTERMARKET

- DF607...(Powered by 302...pr).....5.00
- DF614...(Powered by 302 Windsor...pr).....4.00
- DF608...(Powered by 302 Hi Perf...pr).....4.00

FORD DRAG TEAM DECAL



AFTERMARKET / MISCELLANEOUS

- DZ116...(8"...ea).....7.00

FORD OVAL DECAL



AFTERMARKET / MISCELLANEOUS

- Blue on White Decals

- DF361...(3 1/2" ...ea).....4.00
- DF362...(6 1/2" ...ea).....4.50
- DF363...(9 1/2" ...ea).....5.00
- DF364...(17" ...ea).....8.00

Doors

DOOR PANELS - REPRODUCTION



Quality reproduction

Each panel will fit any year, you remove perforated cut-outs for your application. See website for available colors.

70-77 Maverick & 71-77 Comet

063052...(Standard, no chrome).....	315.00
0630xx...(Top - Basketweave w/chrome mylar).....	Coming Soon
063054...(Top - Woodgrain, w/chrome mylar).....	325.00
063056...(Luxury Décor).....	325.00
063058...(“L” shaped woodgrain, w/chrome mylar).....	325.00
063060...(Standard w/chrome mylar).....	325.00

DOOR PANEL CLIPS



70-77 Maverick & 71-77 Comet

PE150...(15 pkg).....	3.00
-----------------------	------

DOOR PANEL BOARDS



73-77 Maverick & Comet

- Perfect for making custom door panels

FAM-042...(pr).....	69.95
---------------------	-------

WATERSHIELD MATERIAL



12 FT X 2 FT

WSP102...(roll).....	25.00
----------------------	-------

REMOTE SPORT MIRROR BEZEL NUT



70-77 Maverick & 71-77 Comet - All w/remote operated sport mirror

C9TZ17B732A.....	25.00
------------------	-------

**VISIT US ON THE WEB AT:
WWW.MELVINSCLASSICFORDPARTS.COM**

DOOR WATERSHIELDS



- Clear plastic sheeting, goes between door panel and door.

Bottom edge tucks inside door when installing

70-73 Maverick & 71-73 Comet

FAM-261...(pr).....	18.95
---------------------	-------

74-77 Maverick & Comet

FAM-260...(pr).....	18.95
---------------------	-------

DOOR LOCK KNOBS



70-77 Maverick & 71-77 Comet

C8AZ6221850A...(chrome...pr).....	5.25
-----------------------------------	------

73-77 Maverick & Comet

D5OZ6521850B...(chrome /w octagon head...ea).....	5.00
---	------

D5TZ1021850A...(black /w octagon head...ea).....	8.00
--	------

DOOR LOCK GROMMETS



70-77 Maverick & 71-77 Comet

PE246...(clear plastic...pr).....	1.50
-----------------------------------	------

D0DZ6221999...(stainless steel w/felt...pr).....	8.00
--	------

EXTERIOR DOOR HANDLES & PADS



70-77 Maverick & 71-77 Comet

- Includes buttons, pads & hardware

C7ZZ6222404PR...(pr).....	26.95
---------------------------	-------

C7ZZ6522428SET...(pads...4 pc).....	5.75
-------------------------------------	------

DOOR HINGE PIN & BUSHING



70-77 Maverick & 71-77 Comet

- Trimming may be required

PE801...(pin)...(ea).....	2.25
---------------------------	------

PE802...(bushing...ea).....	1.25
-----------------------------	------

Doors

ARMREST / PULL HANDLE



- Correct for 81-86 Mustangs, closest on market to the original, does NOT have chrome bezel at top like factory original. Available in Black or White

24140-15243...(late 73-77...black).....89.95
 24140-15103...(late 73-77...white).....99.95

ARMREST PADS



70-73 Maverick & 71-73 Comet
 - Deluxe available in Black, Blue, White & Ginger
 Must Specify Color & LH or RH side when ordering Deluxe

D1ZZ6524...(deluxe interior...ea).....31.50
 AR101CB...(70-73 standard interior...ea...blue).....40.00
 AR101C...(70-73 standard interior...ea...black).....40.00

ARMREST BASE



70-72 Maverick & 71-72 Comet
 Fits Deluxe Arm rest pad, Black Only

D3DZ6224144...(deluxe interior...ea).....20.00

ARM REST PAD SCREWS



PE236...(pr).....1.00

ARMREST CLIP



70-73 Maverick & 71-73 Comet w/o Molded Arm rest

C6AZ6224146EA...(ea).....2.00
 C6AZ6224146B...(6 pk).....21.95

DOOR HANDLES -INSIDE



70-72 Maverick & 71-72 Comet

D1AZ6522601...(LH...ea).....20.00
 D1AZ6522600...(RH...ea).....20.00

WINDOW HANDLES



70-77 Maverick & 71-77 Comet 2-Door Models

C8AZ6223342A...(before 7/21/69).....11.00
 C9UZ8223342A...(7/21/69 to 10/1/71).....12.00
 D2OZ6523342A...(10/1/71 to 4/2/73).....25.00

73-77 Maverick & Comet 2 & 4 -Door Models

D3AZ6523342A...(after 4/2/73 w/clear knob).....10.50
 D3AZ6523342BLK...(after 4/2/73 w/black knob).....10.50

WINDOW HANDLE KNOBS



70-77 Maverick & 71-77 Comet

C8AZ6223352GL...(ginger).....8.00
 23352BLK...(black).....5.00
 C8AZ6223352MR...(maroon).....8.00
 C8AZ6223352PR...(parchment).....8.00
 C8AZ6223352VE...(vermillion - bright red).....8.00
 C8AZ6223352WT...(white).....8.00
 C8AZ6223352BL...(blue).....8.00
 C8AZ6223352GR...(green).....8.00
 C8AZ6223352IG...(ivy gold).....8.00
 23352CLR...(clear).....5.00

WINDOW HANDLE SCREW



70-77 Maverick & 71-77 Comet

AMK949...(pr).....1.25

WINDOW HANDLE SCREW COVER



70-77 Maverick & 71-77 Comet

PE426...(aluminum discs...pr).....3.25

WINDOW HANDLE ESCUTCHEON



70-77 Maverick & 71-77 Comet

PE465...(plastic discs...pr).....2.00

Doors

DOOR GLASS RETAINER



70-77 Maverick & 71-77 Comet
 - Secures door glass to window channel
D1FZ62234A46A...(ea).....6.00

WINDOW REGULATOR ARM ROLLER



73-77 Maverick & Comet
 * fits 73-77 4-door & 75-77 2-door
D6AZ5323240A.....12.95

DOOR LATCH ROD RETAINER CLIP



70-77 Maverick & 71-77 Comet
C5AZ6221952AR...(ea).....5.50

DOOR LOCK RETAINER



70-77 Maverick & 71-77 Comet
C5AZ6222023A...(ea).....3.00

DOOR/LOCK GASKET



70-77 Maverick & 71-77 Comet
C7AZ6243625A...(ea).....1.50

DOOR BUMPERS



70-77 Maverick & 71-77 Comet
PE199...(2 req...pr).....3.00
PE129...(4 req...4 pkg).....3.75

WINDOW STOP BUMPER



70-77 Maverick & 71-77 Comet
C6OZ7621762S...(ea).....1.50

FRONT DOOR LATCH ASSEMBLY



70-72 Maverick & 71-72 Comet
C9ZZ6321813R...(LH...ea).....65.00
C9ZZ6321812R...(RH...ea).....65.00

DOOR LATCH SCREWS



70-72 Maverick & 71-72 Comet
AMK653...(stainless steel...6 pkg).....3.95

DOOR LATCH REPAIR KIT

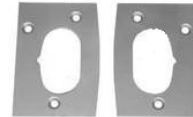

70-77 Maverick & 71-77 Comet
C7ZZ6528160PR...(w/hardware...pr).....25.00

STRIKER PLATES



70-77 Maverick & 71-77 Comet
C5AZ6222008A...(ea).....18.00
C5AZ6222008SS...(polished SS...pr).....59.95

STRIKER PLATE SCREWS



70-77 Maverick & 71-77 Comet
AMK1135...(4 pkg).....3.50
PE562...(stainless steel...4 pkg).....3.00

2-WAY HARNESS LEAD



- Universal
8770.....6.00

RIGHT ANGLE PIGTAIL



Universal - Fits lighter receptacle, console clock, coil, solenoid, ect.
13644.....2.50

SNAP PLUG CONNECTOR



-Universal- 12" Lead
9900...(male end).....2.50
9901...(receiving end).....2.50

CONSOLE CLOCK - POWER FEED HARNESS PIGTAIL



70-73 Maverick & 71-73 Comet
8769.....2.99

BRAKE LAMP SWITCH



70-77 Maverick & 71-75 Comet w/o Power Brakes
SW881.....18.00

DOOR JAMB DOME LIGHT SWITCH



70-75 Maverick & 71-76 Comet
SW1055...(LH...3-prong...ea).....12.95
70-76 Maverick & 71-76 Comet
C8AZ13713C...(LH or RH...2-prong...ea).....7.00
76-77 Maverick & Comet
SW2003.....10.00

DOOR JAMB SWITCH SOCKET



70-76 Maverick & 71-76 Comet
Passenger side ONLY on Mavericks & Comets
Accepts 2 Pins Only
- Holds the wire terminal ends firmly in place on the switch
Originals are almost always brittle & broken – Exact Repro!
C8AZ14489K.....5.25

HORN ASSEMBLY



70-77 Maverick & 71-77 Comet
- Must Modify Bracket
C9ZZ13832.....35.00

HORN SWITCH



70-74 Maverick & 71-74 Comet
- With Standard or Deluxe Steering Wheel
D2AZ13A875A.....105.00

HORN SWITCH / RIM BLOW

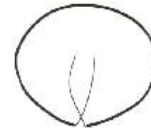

70-73 Maverick & 71-73 Comet
- With 3-spoke steering wheel
D1AZ13A875A.....135.00



INSTRUMENT GAUGE INSULATOR



70-77 Maverick & 71-77 Comet
C9ZZ10C914A.....5.00

INSTRUMENT PANEL LIGHT SOCKET



70-77 Maverick & 71-77 Comet
12237.....3.00

INSTRUMENT VOLTAGE REGULATOR



70-77 Maverick & 71-77 Comet
GR512.....28.00

IGNITION COIL



70-77 Maverick & Comet
B6A12029B...(yellow top).....35.00
D5AZ12029...(75-77 w/Duraspark).....20.00

PERTRONIX IGNITION COIL



70-77 Maverick & 71-77 Comet
40011...(black).....38.95
40001...(chrome).....38.00

PERTRONIX IGNITION



Mavericks & Comets
1281...(70-74...V8).....79.95
1281DV...(70-72 V8 w/dual points).....79.95
1261...(70-74...6 cyl).....79.95

COIL HARNESS PIGTAIL



75-77 Maverick & 71-77 Comet
78-4768...(w/Duraspark).....8.00

DURASPARK HARNESS PIGTAIL



75-77 Maverick & Comet
DY683...(1975).....9.95
DY683A...(75-77).....9.95

DISTRIBUTOR PRIMARY WIRES



70-75 Maverick & 71-75 Comet
DISTV8...(w/yellow boot).....15.75
DIST6CYL...(w/white boot).....5.50

IGNITION SWITCH



70 Maverick Only w/o Locking Column
SW1054...(switch w/ pigtail).....60.00
70 Maverick Only w/o Locking Column
C8AZ11572A...(switch only).....35.00
70 Maverick Only w/o Locking Column
C8AZ11573...(pigtail only).....24.95
71-77 Maverick & Comet
SW992A.....68.00

**VISIT US ON THE WEB AT:
WWW.MELVINSCCLASSICFORDPARTS.COM**

GLASS FUSES

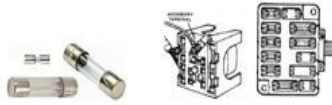

70-77 Maverick & 71-77 Comet

SFE 4.....	1.00
SFE 7.5.....	1.00
SFE 14.....	1.00
SFE 15.....	1.00
SFE 20.....	1.00
AGX 30.....	1.00

FUSES —1970-75

Circuit	Location	Fuse
Emergency Flashers, Cigarette Lighter, and Clock Feed	Fuse Box Terminal #1	ACC 20 / SFE 20
Courtesy, Dome, Glovebox, Luggage Compartment Ignition Buzzer Warning System	Fuse Box Terminal #2	SFE 14
Instruments, Cluster lights, Transmission Quadrant Radio Pilot, Heater and A/C Illum., Windshield Wiper Control, Ash Tray and Clock Illum.	Fuse Box Terminal #3	SFE 4
Warning Lights, Throttle Solenoid and/or Emission and Seat Belt Warning Buzzer and Light (1972-1975)	Fuse Box Terminal #4	SFE 14
Heater and Defroster, Air Conditioning	Fuse Box Terminal #5	SFE 14 (without A/C) 8 AG or AGX 30 (with A/C)
Back-up Lights, Radio, Windshield Washer and Turn Signal Flasher (1974-1975)	Fuse Box Terminal #6	ACC 15 / SFE 15 (1970-1973) SFE 20 (1974-1975)
Optional Equipment, Accessory, Rear Window and Seat Belt Warning (1970-1971)	Fuse Box Terminal #7	ACC 20 / SFE 20
Spotlight	Inline	SFE 7.5

FUSE BOX CLIP REPAIR KIT



70-77 Maverick & 71-77 Comet

FUSECLIPS.....	29.95
----------------	-------

FUSES —1976-77

Circuit	Location	Fuse
Hazard Flashers, Cigarette Lighter	Fuse Box Terminal #1	15 Amp Fuse
Dome Lamp, Key Buzzer, Luggage and Glovebox Compartment Lamp	Fuse Box Terminal #2	15 Amp Fuse
Instrument Panel Lamps, Radio Dial, Heater, Air Conditioning.	Fuse Box Terminal #3	4 Amp Fuse
Warning Lamps, Throttle Solenoid or other Emission Control Equipment	Fuse Box Terminal #4	14 Amp Fuse
Heater/ Defroster Motor (With A/C) Air Conditioning Motor	Fuse Box Terminal #5	14 Amp Fuse (30-Amp)
Back-up Lights and Turn Signal Flasher	Fuse Box Terminal #6	15 Amp Fuse
Blank	Fuse Box Terminal #7	
Radio	Fuse Box Terminal #8	7.5 Amp Fuse
Windshield Wiper Motor and Accessory	Fuse Box Terminal #9	15 Amp Fuse
Blank	Fuse Box Terminal #10-12	



NEUTRAL SAFETY SWITCH



71-72 Maverick & Comet
SW1615.....69.95

ALTERNATOR WIRING HARNESS



71 Maverick & Comet
ALT15...(All 6 cyl & 302).....45.00
72 Maverick & Comet
ALT17...(200, 250 & 302).....45.00
ALT17...(250 from 12/1/71).....45.00
ALT20...(302 from 12/1/71).....45.00
73 Maverick & Comet
ALT21...(200 & 250).....45.00
ALT20...(302).....45.00

HEADLIGHT SWITCH



70-77 Maverick & 71-77 Comet
D3ZZ11654A...(70-77).....20.00

HEADLIGHT "ON" WARNING KIT



- Made for 64-73 Mustangs but can be adapted to fit your Maverick or Comet.
Designed to activate buzzer when ignition is turned off and the parking or headlights are left on. No permanent alteration to the car's wiring is required. Instructions included.
C6AZ14931AR.....26.95

HEADLIGHT DIMMER SWITCH



70-77 Maverick & 71-77 Comet
SW263.....10.00

HEADLIGHT DIMMER SWITCH PIGTAILS



70-77 Maverick & 71-77 Comet
11437.....3.95

HEADLIGHT PIGTAIL



70-77 Maverick & 71-77 Comet
5225.....3.95

BACK-UP LAMP SOCKET



70-77 Maverick
3251...(ea).....5.00

ENGINE/TRUNK COMPARTMENT LIGHT



70-72 Maverick & 71-72 Comet
- Dealer Add-on - Can be added to any year
C2RZ15A700A.....25.00

MARKER LIGHT PIGTAIL



70-77 Maverick & 71-77 Comet
D0DZ15434.....5.00

**VISIT US ON THE WEB AT:
WWW.MELVINSCLASSICFORDPARTS.COM**

PARKING LAMP SOCKET



- 71-74 Maverick & Comet - (Grille Mounted Parking & Sport Lamps)
BAAA13410.....**5.00**
- 75-77 Maverick & Comet - (Grille Mounted Parking Lamps)
D4OZ13234A.....**10.00**

REAR LICENSE LAMP ASSEMBLY



- 70-73 Maverick & 71-73 Comet
D1ZZ13560.....**31.50**

TAIL LAMP SOCKET



- 70-77 Maverick
8756.....**5.00**
- 71-77 Comet - (will NOT replace Reverse/Back-Up Lamp Socket)
- Minor filing/trimming to ears may be required
D4OZ13234A.....**10.00**

TRUNK LIGHT - FACTORY STYLE

- Replacement w/Mercury Activated Switch



- 70-77 Maverick & 71-77 Comet
68-TRUNK-CPE-CV...(72").....**45.00**

HEATER BLOWER MOTOR



- 70 Maverick
35540...(w/o A/C).....**59.95**
- 71-77 Maverick & Comet
35502...(w/o A/C).....**49.95**

HEATER CONTROL & CLOCK LIGHT PIGTAIL



- 70-77 Maverick & 71-77 Comet
8761.....**5.00**

HEATER SWITCH TO BLOWER MOTOR RESISTOR ASSEMBLY



- 70-77 Maverick & 71-77 Comet
C8OZ18591A...(HEATER ONLY).....**22.00**
- C8ZZ19A706A...(FACTORY AC EQUIPPED)**.....**22.00**

*This is correct for 68-73 Mustangs with A/C, but can be used on A/C equipped 70-75 Mavericks & 71-75 Comets, may have to trim red fiber board to fit placement on fan housing.

STARTER SOLENOID



- 70-71 Maverick & 71 Comet
Black
C7AZ11450-A1...(w/Autolite logo).....**45.00**
- 72-77 Maverick & Comet
Black
D2AF11450AA...(w/Motorcraft logo).....**45.00**
- 70-77 Maverick & 71-77 Comet
SW3...(generic).....**15.00**

TURN SIGNAL SWITCH



- 70 Maverick (without locking column)
C9AZ13341B.....**99.00**
- 70-72 Maverick & Comet (w/locking column)
D2AZ13341C.....**119.95**
- 73-77 Maverick & Comet (w/locking column)
D6DZ13341B.....**85.00**

TURN SIGNAL SWITCH HARNESS CONNECTOR



70-72 Maverick & 71-72 Comet
C8AZ14489S.....**6.50**

EMERGENCY / HAZARD FLASHER



70-77 Maverick & 71-77 Comet
SF552B.....**8.00**

TURN SIGNAL FLASHER RELAY



70-77 Maverick & 71-77 Comet
C5AZ13350B.....**12.95**

VOLTAGE REGULATOR



38 / 42 Amp
70-71 Maverick & 71 Comet
D0AF-AUTOLITE...(w/o AC).....**45.00**

72 Maverick & Comet
D2AF-MOTORCRAFT...(w/o AC).....**45.00**

73 - Maverick & Comet
D3AF-MOTORCRAFT...(w/o AC).....**45.00**

45 / 55 Amp
72 - Maverick & Comet
D2TF-MOTORCRAFT...(w/AC).....**45.00**

73 - Maverick & Comet
D3TF-MOTORCRAFT...(w/AC).....**45.00**

VOLTAGE REGULATOR PIGTAIL



70-77 Maverick & 71-77 Comet
11445.....**8.00**

WIPER SWITCH



73-77 Maverick & Comet
- w/o Intermittent Wipers-
D1ZZ17A553A.....**35.00**

INTERMITTENT WIPER SWITCH



70-77 Maverick & 71-77 Comet
- w/Intermittent Wiper Conversion- Switch alone does not provide
intermittent wiper function. Correct/years for Ford Trucks/Broncos.
These have Blades, not Pins.
D10Z17A553A...(73-79).....**85.00**
E7TZ17A553A...(80-91).....**125.00**

WIPER MOTOR - REPLACEMENT



70-77 Maverick & 71-77 Comet
NOTE: This wiper motor has different wire colors than original. Remove
Original plug and wires from your old wiper motor and connect wiring:
Blue wire on new motor to Blue wire on original plug/harness
Green wire on new motor to White wire on original plug/harness
Red wire on new motor to Red wire on original plug/harness
White wire on new motor to Black wire on original plug/harness
Black wire on new motor is just an additional ground, connect to bracket.
C7ZZ17508.....**89.95**

WASHER RESERVOIR PUMP



70-77 Maverick & 71-77 Comet
C9AZ17664A.....**20.00**



WINDSHIELD WASHER PUMP HARNESS CONNECTOR



70-77 Maverick & 71-77 Comet
17621.....5.00

HARNESS WRAP - CLOTH TAPE



1" x 140"
B11666.....10.00

INSULATOR BUSHING - REAR WINDOW DEFOGGER MOTOR WIRING



- Protects defogger motor wiring on rear package shelf where wire passes through 1" hole
16093.....1.25

WIRE LOOM RETAINER



70-77 Maverick & 71-77 Comet
- Used on various wiring looms
C7AZ13A506S.....2.25

WIRING RETAINER



70-77 Maverick & 71-77 Comet
Wiring to Top of Left Shock Tower
B13115...(4 pc).....3.25
Front Marker Light Harness
B13113...(4 pc).....3.25
Headlamp Harness to Radiator Support
B13117...(3 pc).....3.25



WIRE STRAP



376914S..... .75

WIRING STRAP



70-77 Maverick & 71-77 Comet
B10977...(3 1/4" long..2 pkg).....3.00



Engine

AC IDLER PULLEY



72-77 Maverick & Comet
7-150...(302 w/AC).....75.00

AIR CLEANER - V8



12" Oval-Ball Milled w/5-1/8" Neck
R6020.....65.00
12" Oval-w/Flames
R6020X.....69.95
Chrome - "Ford Racing"
302-350.....65.00
Chrome w/Black "Ford Racing"
302-351.....85.00
Black Crinkle w/Red "Ford Racing"
302-352.....85.00
Black Crinkle w/Red "Cobra"
302-372.....85.00
Chrome w/Black "Cobra"
302-371.....85.00
Oval - Black - Plain
S1MS9600P.....99.00
Black Crinkle w/Silver "Ford Racing"
302-380.....140.00
Ford Blue w/Silver "Ford Racing"
302-381.....140.00
Cast Gray Crinkle w/Silver "Ford Racing"
302-382.....140.00
Polished S/S w/Black "Ford Racing"
302-383.....140.00
Chrome w/Black "Ford Racing"
302-384.....180.00

BUSINESS HOURS
TUES-FRI 8:30-5:00
SATURDAY 8:30-2:00
CLOSED SUNDAY AND
MONDAY
EASTERN STANDARD TIME

SNORKEL - THERMO DOOR SPRING



71-72 Maverick & Comet
C8AZ9A652B...(302).....10.00

AIR CLEANER HEAT SHROUD



71 Comet
C8AZ9A603C...(302).....70.00

AIR CLEANER LID GASKET



- Cut To Fit
C8ZZ9673.....8.00

AIR CLEANER SNORKEL HOT AIR TUBE



70-77 Maverick & 71-77
C9UZ9652A...(2" I.D. x 18").....28.00

AIR CLEANER WING NUTS



70-77 Maverick & 71-77 Comet
383132S...(6 cyl...ea).....2.25
358871...(V8...ea).....2.25

"FORD" AIR CLEANER WING NUT



302-333...(blue w/chrome).....11.95
302-339...(black w/red).....11.50
302-334...(black w/chrome).....11.50

Engine

ALTERNATOR



70-77 Maverick & 71-77 Comet
 Chrome, All New Unit
7078NA...(60 amp).....149.95

ALTERNATOR BRACKET & ADJUSTMENT ARM



70-77 Maverick & 71-77 Comet – V8
C5ZZ10145/51BK...(black).....18.95
C5ZZ10145/51K...(chrome).....18.95

ALTERNATOR FAN



70 Maverick
C5AZ10A310B...(w/13 blades).....10.50
 70-77 Maverick & 71-77 Comet
D0AZ10A310B...(w/10 blades).....15.75

ALTERNATOR PULLEYS



70-73 Maverick & 71-73 Comet
C5AZ10344K...(single groove).....20.00
C5AZ10344L...(double groove).....20.00

ALTERNATOR SPACER



71-73 Maverick & Comet - V8 ONLY
D0OE10A370B.....11.25

**VISIT US ON THE WEB AT:
 WWW.MELVINSCCLASSICFORDPARTS.COM**

ALTERNATOR SPLASH SHIELD



70-77 Maverick & 71-77 Comet - 6 cyl w/AC
D1DZ10317A.....18.95

CHOKE TUBE



70 Maverick
LCH7001...(250).....20.00
 71 Maverick & Comet
LCH7101...(200).....20.00
 72 Maverick & Comet
LCH7201...(302...2 pc.).....20.00

EXHAUST MANIFOLD CHOKE STOVE REBUILD KIT



70-77 Maverick & 71-77 Comet - V8
CK10...(kit).....30.00

COIL BRACKET



70-77 Maverick & 71-77 Comet W/V8 (302)
C4DZ12043A...(black).....13.00
C4DZ12043S...(stainless).....18.00

DISTRIBUTOR HOLDDOWN



70-77 Maverick & 71-77 Comet
 Fits 6 cyl & V8
C5ZZ12270...(chrome).....5.95
IM-FE-DC...(stainless steel).....24.95

Engine

DISTRIBUTOR VACUUM CONTROL WATER NECK VALVE ASSEMBLY



74-77 Maverick & Comet - 6cyl & V8 (Operates at 125°)
D5ZZ8A564A.....20.00

FREEZE PLUG KIT - BRASS



70-77 Maverick & 71-77 Comet
381-8015...(V8).....13.95
381-8013...(6 cyl).....13.95

OIL FILTER



70-72 Maverick & 71-73 Comet
C5ZZ6731WHITE...(FL-1 Autolite, 6 cyl & V8).....35.00
73-77 Maverick & Comet
FL1A.....6.95
FL1HP...(Hi-Perf - Motorcraft Racing).....13.50

OIL FILTER COVER



70-77 Maverick & 71-77 Comet (6 cyl & V8)
C5ZZ6731C.....9.95

ENGINE COMPARTMENT LIGHT



70-72 Maverick & 71-72 Comet
- Dealer Add-on - Can be added to any year
C2RZ15A700A.....25.00

HARMONIC BALANCER



70-77 Maverick & 71-77 Comet
C2DZ6312R...(170/200 single groove).....99.00
D2OZ6316A...(302 - 4 bolt).....125.00

HARMONIC BALANCER - HARDWARE



70-77 Maverick & 71-77 Comet
AMK1191...(302).....5.00
AMK281...(6 cyl).....5.00

HEATER HOSE CONNECTION - ENGINE SIDE



70-77 Maverick & 71-77 Comet
C2OZ18599B...(170/200).....23.95
8M18599...(250).....16.25
C6AZ18599B...(302...gold zinc).....17.00
C6AZ18599C...(302...chrome).....25.00

THERMOSTAT HOUSING



70-77 Maverick & 71-77 Comet
C1DZ8592D...(6 cyl).....18.95
C5OE8592A...(302...w/recess).....19.95
C5ZZ8592C...(302...chrome).....18.00
35067...(gasket...302).....2.00

THERMOSTAT / WATER NECK HARDWARE



70-77 Maverick & 71-77 Comet
AMK504...(170/200).....3.68
AMK505...(250).....3.68
AMK506...(302).....3.68

Engine

THERMOSTAT



70-77 Maverick & 71-77 Comet	
6 cyl or V8	
RT350...(160°).....	8.95
RT351...(180°).....	7.95
RT1139...(190°).....	7.95

FRAME SUPPORT



71-77 Maverick & 71-77 Comet	
D0DZ6030PR...(302...pr).....	169.95

MOTOR MOUNT



70-72 Maverick & 71-72 Comet	
2333...(6 cyl...LH or RH...ea).....	21.95
73-77 Maverick & Comet	
2341...(6 cyl...LH or RH...ea).....	15.00
71-77 Maverick & Comet	
2316...(302...LH or RH...ea).....	25.00

TIMING CHAIN SET & COVER



71-77 Maverick & Comet - V8 (302)	
KT3-351S...(timing chain set...170/200).....	35.00
KT3-358S...(timing chain set...302).....	35.00
D3OZ6019A...(cover without pointer).....	69.95

TIMING CHAIN COVER GASKET



TCS13059...(170/200).....	18.95
TCS45059...(250).....	18.95
TCS45008...(302).....	19.25

OIL CAP



70 Maverick (6 Cylinder 170, 200, 250)	
C5ZZ6766B...(closed emission).....	20.00
C5ZZ6766D...(closed emission - chrome).....	20.00



71-77 Maverick & Comet	
D1ZZ6766A...(black twist...4 pc).....	30.00
D1ZZ6766C...(chrome twist...4 pc).....	35.00

OIL CAP - AFTERMARKET



71-77 Maverick & Comet - V8 302	
302-200...(chrome - Ford Racing twist type).....	10.95
302-215...(chrome - Ford Racing push in type).....	10.95
302-216...(black - Ford Racing push in type).....	14.00
302-226...(black - Ford Cobra push in type).....	14.00

OIL CAP ADAPTER TUBE



C5AZ6A868A.....	12.00
-----------------	-------

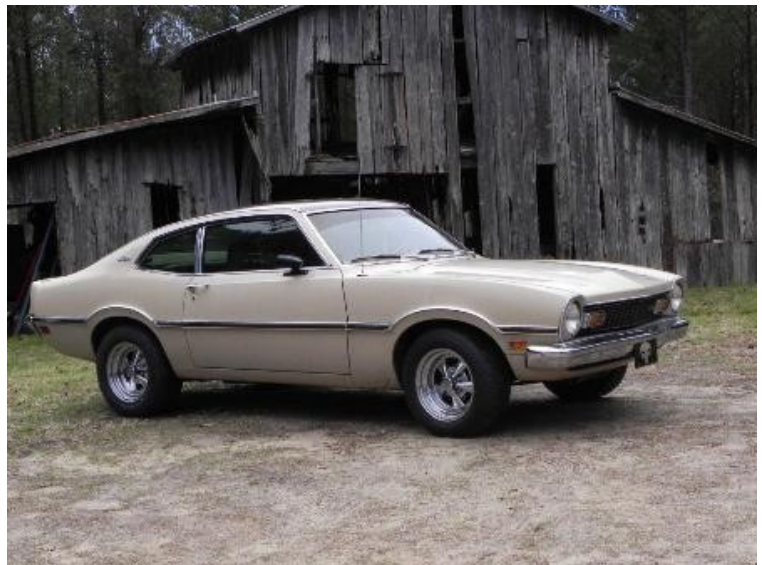

Engine

OIL PAN



70-77 Maverick & 71-77 Comet

D5DZ6675R...(170/200).....	155.00
C5ZZ6675...(302).....	60.00
C5ZZ6675C...(302 chrome).....	80.00

OIL PAN GASKET



OS12701C...(pan gasket - 170/200).....	16.95
OS30217C...(pan gasket - 250).....	16.95
OS13260C...(pan gasket - 302).....	17.50

OIL PAN HARDWARE



AMK3486...(170/200/250).....	16.50
AMK484...(302).....	16.85

OIL PRESSURE SENDING UNIT



70-77 Maverick & 71-77 Comet

SW1311.....	29.95
-------------	-------

OIL PRESSURE SENDING UNIT EXTENSION



C2OZ9B339A.....	21.95
C2OZ9B339C...(chrome).....	28.00

OIL PUMP



70-77 Maverick & 71-77 Comet

224-41118...(302).....	40.00
224-41165...(250).....	70.00
224-41146...(170/200).....	60.00

OIL PUMP PICKUP SCREEN



70-77 Maverick & 71-77 Comet

224-11118...(302).....	20.00
224-11165...(250).....	30.00
224-11146...(170/200).....	30.00

OIL PUMP SHAFT



70-77 Maverick & 71-77 Comet

224-61118...(302).....	15.00
224-61165...(250).....	15.00
224-61120...(170/200).....	15.00

WATER PUMP PULLEY



70-72 Maverick & 71-72 Comet

C3OZ8509B...(170 w/o A/C).....	55.00
--------------------------------	-------

PCV ELBOW



70-77 Maverick & 71-77 Comet

- All engines requiring use of	
C8AZ6767A.....	12.95

PCV GROMMET



70-77 Maverick & 71-77 Comet

8 Cylinder (302)	
C6AZ6892...(“D” shaped).....	4.00
C8SZ6892...(6 or 8 cyl, use w/elbow).....	2.00

PCV HOSE



Molded hose, can be cut to your desired length
- Clamp may be needed for your application

D1TZ6A664A...(6 or 8 cyl).....	16.95
--------------------------------	-------

Engine

PCV VALVES



EV68C...(70-73...6 cyl).....	6.25
EV50...(71-72...V8).....	6.25
EV68C...(73-77...V8).....	6.25

SPARK PLUG



1970-1977	
BSF82C...(6 cyl...ea).....	2.95
1970-1973	
BSF42C...(V8...ea).....	2.95

SPARK PLUG WIRES



1970-1975	
706101...(6 cyl - by Pertronix).....	52.95
1971-1974	
708105...(302 - by Pertronix).....	52.95
1975-1977	
708104...(302 Duraspark - by Pertronix).....	52.95
1970-1974	
SPW25...(6 cyl-OEM style).....	55.00
1971-1974	
SPW26...(302-OEM style).....	58.00

WIRE DIVIDERS



B6A12297K...(OEM Style - V8).....	5.95
302-637...(blue w/Ford Oval).....	12.95
302-641...(black w/Ford Oval).....	12.95

***** PRICES ARE SUBJECT TO CHANGE *****

See disclaimer in front of catalog. Refer to website for current pricing. Confirm prices upon ordering.

WIRE LOOM KITS



302-636...(chrome w/blue "Ford Racing").....	12.95
302-640...(chrome w/black "Ford Racing").....	12.95

VALVE COVER BOLTS



70-77 Maverick & 71-77 Comet	
* Includes enough to do one engine	
AMK480...(6 cyl).....	7.50
AMK481...(V8).....	12.50

VALVE COVER BOLTS



- Mini-Nuts - Hi quality steel with Ford Oval cut sharply into the top	
- all nuts are supplied with a separate stud which permits precise gasket positioning on the head prior to mounting the valve covers -	
1/4-20 threads- 4 per pkg.	
302-315...(chrome...4 pkg).....	11.25
302-316...(black...4 pkg).....	15.00

VALVE COVER WING NUTS – AFTERMARKET



302-325...(chrome w/Ford Oval).....	21.95
302-326...(black w/Ford Oval).....	21.95



Engine

VALVE COVERS



70-73 Maverick & 71-73 Comet
6 Cylinder (170, 200, 250)
C4DZ6A582P...(blue).....55.00
C4DZ6A582A...(chrome).....40.00

VALVE COVERS - V8 AFTERMARKET



302-001...(pol. alum. w/black "Ford Racing"...pr).....139.95
302-002...(chrome alum-w/black "Ford Racing"...pr).....289.00
302-003...(black alum-w/red "Ford Racing"...pr).....159.95
302-070...(chrome "Ford Racing"...pr).....80.00
302-071...(chrome w/black "Ford Racing"...pr).....90.00
302-072...(black w/red "Ford Racing"...pr).....85.00
302-055...(pol. alum. w/black "Ford Cobra"...pr).....159.95
302-056...(black alum w/red "Ford Cobra"...pr).....159.95
302-116...(chrome w/black "Ford Cobra"...pr).....90.00
302-117...(black w/red "Ford Cobra"...pr).....90.00
6A582-CT...(Comet).....179.95
6A582-MAV...(Maverick).....179.95
6A582-302...(302).....159.95

VALVE COVERS - FORD



71-73 Maverick & Comet
8 Cylinder (302)
C8OZ6A582BL...(blue).....60.00
C5ZZ6A582C...(chrome).....60.00

VALVE COVER GASKETS



70-77 Maverick & 71-77 Comet
VS12692C...(6 cyl).....11.50
VS13264C...(302).....15.00

ENGINE OIL DIPSTICK - (170/200 6 Cyl)



70-72 Maverick & 71-72 Comet - (170 6 cyl)
70-74 Maverick & 71-74 Comet - (200 6 cyl)
*Includes dipstick and dipstick tube
C2DZ6750B...(2 pc).....25.00

ENGINE OIL DIPSTICK - (V8 302)



C5AZ6750A...(blue handle - dipstick only).....15.75
C5AZ6750C...(s/s handle - dipstick only).....18.00



302-400...(chrome - w/blue Ford cap dipstick & tube).....25.00
302-401...(chrome - dipstick & tube).....18.00

BRAD PENN BREAK-IN OIL



009-7120...(30W...qt).....7.99

BRAD PENN RACING OIL



009-7139...(SAE30...qt).....7.99
009-7140...(SAE40...qt).....7.99
009-7119...(20W50...qt).....8.49
009-7150...(10W30...qt).....8.49

*** PRICES ARE SUBJECT TO CHANGE***

See disclaimer in front of catalog. Refer to website for current pricing. Confirm prices upon ordering.

Engine

UNDER HOOD COVER - (Oversize S/H)



EXAMPLE

- Made of High Temperature ABS w/heat shield insulation panels, Pre-cut, ready to install. Manufactured to cover structural ribs on the underside of the hood surface. Mounting pins and illustrated Instructions included. - Black Only.

70-77 Maverick

MAVRICK7077-CUHC...(Smooth - No Logo).....	169.00
MAVRICK7077-CUHC-F93...("Grabber").....	239.00
MAVRICK7077-CUHC-F75...("Maverick").....	239.00
MAVRICK7077-CUHC-F94...("Stallion").....	239.00
COM7077-CUHC.....	239.00

HOOD INSULATION



70-77 Maverick & 71-77 Comet

FAM-082...(pre-cut).....	45.00
--------------------------	-------



Exhaust

DONUT GASKET



70-77 Maverick & 71-77 Comet

9802...(6 cyl...ea).....	3.50
8194...(302...ea).....	3.50

EXHAUST MANIFOLD BOLT - HEAT SHIELD



- Used to secure factory heat shield to exhaust manifold
Sold as a pair

B12473...(200/250...pr).....	6.50
B12471...(302...ea).....	6.50

EXHAUST MANIFOLD BOLTS



AMK526...(200/250...11 pc).....	20.00
AMK527...(302...16 pc).....	24.75

EXHAUST MANIFOLD GASKET



70-77 Maverick & 71-77 Comet

MS9789-1...(6 cyl...ea).....	12.95
MS9000...(302...ea).....	15.75

EXHAUST MANIFOLD STUD BOLTS



70-77 Maverick & 71-77 Comet

AMK522...(200/250).....	8.50
-------------------------	------

HEADERS - (Oversize S/H)



70-74 full length - 302

D668R...(pr).....	449.00
-------------------	--------

EXHAUST PAINT - (No Return on Paint)



Hi-Temp

Black Velvet - Up to 1200°

Manifold Gray - Up to 1400°

POR-20 Aluminum - Up to 1400°

POR44116...(8 oz - black velvet).....	19.75
PORBVP...(pint - black velvet).....	32.75
POR44216...(8oz - factory manifold gray).....	19.75
POR44208...(pint - factory manifold gray).....	32.75
POR44316...(8oz - brilliant aluminum).....	20.75
POR44308...(pint - brilliant aluminum).....	34.25

EXHAUST MANIFOLD HEAT SHROUD



71 Comet

C8AZ9A603C...(302).....	70.00
-------------------------	-------

EXHAUST MANIFOLD CHOKE STOVE REBUILD KIT



70-77 Maverick & 71-77 Comet - V8

CK10...(kit).....	30.00
-------------------	-------



Exterior

ANTENNA



70-77 Maverick & 71-77 Comet
Telescoping Replacement w/rectangle base
D0DZ18813A...(70-72 exact repro).....90.00
D1ZZ18813.....75.00
D3AZ18813R.....18.95

BUMPER GUARD PADS



70-73 Maverick & 71-73 Comet
D1ZZ17A812PR...(71-72 front...pr).....69.95
D3ZZ17807...(73 front & rear...pr).....20.00

HORIZONTAL REAR BUMPER PADS



73 Maverick & Comet
- Trimming/Slight modification may be required
D3ZZ17830...(center pad...ea).....75.00
D3ZZ17831...(curved ends...pr).....75.00

COWL VENT REPAIR KIT



70-77 Maverick & 71-77 Comet
C5ZZ6502010K.....19.95

EXTERIOR DOOR HANDLES & PADS



70-77 Maverick & 71-77 Comet
- Includes buttons, pads & hardware
C7ZZ6222404PR...(pr).....26.95
C7ZZ6522428SET...(pads...4 pc).....5.75



Melvin's Classic
Ford Parts
PHONE: 770-761-6800



FENDER EMBLEM



70-74 Maverick
D0DZ16098A...(ea).....27.95

FRONT LICENSE PLATE BRACKET



1973 Maverick & Comet Only
D3ZZ17A385B...(ea).....20.00

FRONT CHIN SPOILER



70-73 Maverick & 71-73 Comet
- This is for 1970 Shelby Mustang and has been successfully added to Mavericks/Comets with no issues. No mounting instructions included.
FS70M...(fiberglass).....110.00

CHIN SPOILER HARDWARE KIT



AMK976.....7.25

(F. O. R. D) - HOOD / DECKLID LETTERS



75-77 Maverick
C7AZ16606AD.....10.50

*****PRICES ARE SUBJECT TO CHANGE*****
See disclaimer on front of catalog. Refer to website for current pricing. Confirm prices upon ordering.

Exterior

HOOD ORNAMENT



73-76 Maverick
E2BZ16850A.....75.00

HOOD PIN KIT



S1MS16892DLX.....24.95

HOOD SCOOP

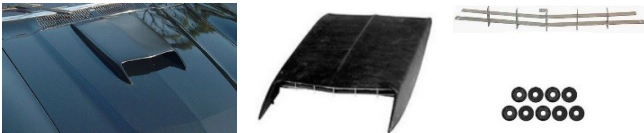

70-77 Maverick & 71-77 Comet
- This is for the 1969 Mustang and has been successfully added to Mavericks/Comets with no issues. No mounting instructions included.
C9ZZ16C630A...(scoop).....140.00
C9ZZ16A624C...(scoop grille).....49.95
AMK146...(scoop hardware).....15.75

HOOD SCOOPS – “GRABBER”



70-72 Maverick
5003...(pr).....145.00

HOOD MOUNTED TACH - (Special Order - No Return)



Black Plastic Housing - Holes must be drilled in hood for proper installation
C8AZ17A326B...(Black w/Black face).....389.95
C8AZ17A326W...(Black w/White Face).....389.95

VINYL TOP



70-77 Maverick & 71-77 Comet
VT50...(2 Door - black).....149.95
VT51...(4 Door - white).....149.95

WINDSHIELD



70-77 Maverick & 71-77 Comet
* Fits 2-Door & 4-Door Models
- Price does NOT include Truck Freight & box fee, call for additional info.
DW797GBN...(windshield).....225.00
D2DZ6203110A...(windshield gasket).....75.00



Fuel

ACCELERATOR CABLE



71-77 Maverick & 71-77 Comet
 W/ball type cable-v8 302 only 24" - original cables for 71-74 were 21"
 & 75-77 were 20" - at present, this is the closest on the market.
D7TZ9A758A.....95.00

ACCELERATOR PEDAL BOLT



70 Maverick
C8OZ9873.....5.00

ACCELERATOR PEDAL



71-77 Maverick & Comet
 - Correct for Mustang. Measures 5 1/4", original measures 6 1/2"
 Mounts the same, you will have to shorten your spring.
D1ZZ9735.....18.95

ACCELERATOR PEDAL SPRING



70-72 Maverick & 71-72 Comet
C9OZ9760...(70 Maverick prior to 6/16/69).....3.50
C5AZ9C804B...(71-72 Maverick & Comet).....4.50

ACCELERATOR RETRACTING SPRING



70 Maverick
C9ZZ9737FR.....19.50

CARBURETOR GASKET

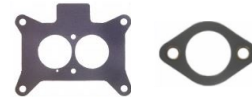

71-77 Maverick & Comet
60094...(2V carb).....3.25
60084...(250).....3.50

CARBURETOR REBUILD KIT



70-77 Maverick & 71-77 Comet
D0DZ9A586B...(170/200).....26.95
586...(70-74 V8 2100 series 2v).....27.95
D9PZ9A586N...(75-77 V8 2100 series 2v).....35.95

FILLER PIPE TO FUEL TANK SEAL



71-75 Maverick & Comet
D1ZZ9072...(before 5/1/75).....19.50
 75-77 Maverick & Comet
E1AZ9072B...(after 5/1/75).....18.95

FILLER PIPE SEAL SCREWS



70-77 Maverick & 71-77 Comet
AMK992.....3.50

FUEL FILLER TUBE TO TRUNK FLOOR SEAL



71-77 Maverick & Comet
D1ZZ9008.....23.95

FUEL FILLER PIPE SCREWS



70-77 Maverick & 71-77 Comet
AMK413.....3.50



Fuel

FILLER PIPE TO BODY GASKET



70-77 Maverick & 71-77 Comet
C5ZZ9076A.....2.95

FUEL FILTER



70-77 Maverick & 71-77 Comet
FG14C...(3/8" ...thread).....6.95
S9247...(aftermarket-glass/chrome).....10.00

FUEL HOSE



70-77 Maverick & 71-77 Comet
 5/16" Sold by the foot
65127...(per ft).....1.50
 5/16" "Gas" Script hose – sold by the foot
FH01...(per ft).....6.95

FUEL LINES - (**Upsize S/H**)



(Pre-Bent, Appropriate fittings, Ready to install)
 70 Maverick
LGL7001...(3/8" ...plump to tank...2pc).....75.00
LGL7001S...(stainless steel).....115.00
 70 Maverick
LPC7001...(250...pump to carburetor).....30.00
LPC7001S...(stainless steel).....40.00
 71-74 Maverick & Comet
LGL7101...(3/8" ...plump to tank...2pc).....75.00
LGL7101S...(stainless steel...2pc).....115.00
 75 Maverick & Comet
LGL7501...(5/16" ...plump to tank).....75.00
LGL7501S...(stainless steel).....115.00

BUSINESS HOURS
TUES-FRI 8:30-5:00
SATURDAY 8:30-2:00
CLOSED SUNDAY AND
MONDAY
EASTERN STANDARD TIME

FUEL LINE GROMMET ON APRON



70-77 Maverick & 71-77 Comet...All 6 cyl & V8
D1ZZ9288...(ea).....2.00

FUEL PUMP



70 Maverick
6399...(6 cyl).....45.00
 71-74 Maverick & Comet
6092...(6 cyl).....40.00
 71-74 Maverick & Comet
6588...(302).....45.00

FUEL PUMP BLOCK-OFF PLATE



302-290...(chrome w/Ford Oval).....8.00
302-291...(black w/Ford Oval).....12.00

FUEL CAP – OPTIONS



70-77 Maverick & 71-77 Comet
 - Note, Pop-Open cap fits all filler necks that have a filler neck screw at the Twelve O'clock position
215488F...(pop-open).....135.00
B9030P-BLK...(billet - black).....95.00
B9030P...(plain billet).....95.00
C3DZ9030A...(non-vented 63-64 Falcon- chrome).....58.95

FUEL CAP GASKET

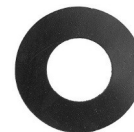

70-77 Maverick and 71-77 Comet
 Seals cap to filler neck to prevent fumes/fuel from escaping
9030R.....1.50

Fuel

FUEL CAP LOCK



70-77 Maverick & 71-77 Comet
 - For twist off type fuel caps. Assembly Required.
 Helps to prevent theft of Deluxe Gas Caps, mounts in trunk.
ACC-9030-LOCK.....12.00

FILLER PIPE TO FUEL TANK HOSE



1970 Maverick
C8ZA9047.....6.50

FUEL TANK – 19 Gallon



71-77 Maverick & Comet
 *Correct for 76 & 77 model, but will fit 71-75 Maverick & Comet with minimum modification. Must install new vapor valve, grommet and tank straps below for this installation in a 71-75 model Maverick or Comet. Recommended to replace your used vapor valve and grommet if installing in a 76 or 77 model.
F30.....245.00

FUEL TANK VAPOR VALVE



71-75 Maverick & Comet (if using tank above) &
 76-77 Maverick & Comet
 *FOR USE WITH ABOVE TANK
E7DZ9B593A.....20.00

FUEL VAPOR VALVE GROMMET



*For use with above tank and vapor valve
F6TZ9B076AA.....7.95

FUEL TANK STRAPS

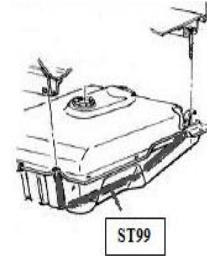

76-77 Maverick & Comet
 - For use with F30 fuel tank above or to replace damaged straps on 76-77 models if installing F30 Fuel tank in 71-75, longer bolts can be used instead of buying these straps...your decision. Longer bolts are NOT sold by Melvin's Classic Ford Parts. We recommend using the longer straps designed for the tank.
ST99.....39.95

FUEL TANK STRAP MOUNTING BOLTS



71-77 Maverick & Comet
 - Used to fasten straps under Fuel tank to vehicle- Will not work if using 71-75 straps to secure a 76-77 Fuel Tank
AMK1411...(pr).....6.75

FUEL SENDING UNITS



- w/Float, Filter & Gasket
 70 Maverick
D0DZ9275A.....69.95
 71-74 Maverick & Comet
D1DZ9275A.....109.95
 76-77 Maverick & Comet
D6DZ9275A...(5/16").....69.95

FUEL TANK SENDING UNIT FILTER



70-77 Maverick & 71-77 Comet
D1AZ9A011A...(3/8" tube).....12.95
D1FZ9A011A...(5/16" tube).....12.95



Fuel

FUEL TANK FLOAT – BRASS



71-77 Maverick & Comet
68-9275S.....10.00

FUEL TANK SENDING UNIT “O” RING



70-77 Maverick & 71-77 Comet
C0AF9276A.....1.65

VAPOR CANISTER HOSE



70-77 Maverick & 71-77 Comet – (All 6 cyl & V8)
3/4” x 36”, Aluminum Reproduction Replacement
- Can be spray painted flat black for OEM appearance.
DIUZ9D667A..... 24.95

FUEL TANK SEALER - POR15



70-77 Maverick & 71-77 Comet... All Fuel Tanks
POR49216...(8 oz).....13.00
POR49208...(pint).....24.95
POR49204...(quart).....42.95

MARINE CLEAN/METAL READY - POR15



Marine Clean removes gum, sludge & varnish from fuel tank.
POR40104...(quart).....11.75
Metal Ready removes rust from fuel tank and prepares it for sealing.
POR40204...(quart).....18.00

*** PRICES ARE SUBJECT TO CHANGE***

See disclaimer in front of catalog. Refer to website for current pricing. Confirm prices upon ordering.

POR 15 - FUEL PRESERVATIVE & STABILIZER



Keep The Fuel System Trouble-Free
PORFFP...(pint).....14.25
PORFPQ...(quart).....20.25

FUEL TANK SENDING UNIT RETAINING RING



70-77 Maverick & 71-77 Comet
C0AZ9A307B.....4.00



BUSINESS HOURS
TUES-FRI 8:30-5:00
SATURDAY 8:30-2:00
CLOSED SUNDAY AND
MONDAY
EASTERN STANDARD TIME



Hardware

AC / HEATER CABLE CLAMP & SCREW



70-77 Maverick & 71-77 Comet
 - Secures heater/defrost cables
PE373.....6.00

SERVICE VALVE CAPS



70-73 Maverick & 71-73 Comet
14-107...(pr).....24.95

APRON TO J-BOLT "L" BRACKET



70-77 Maverick & 71-77 Comet
C9ZZ10A705A...(ea).....14.45

BATTERY CLAMP "J" BOLT



70-77 Maverick & 71-77 Comet
PE417...(ea).....2.00
PE417SS...(stainless steel...pr).....14.95

BATTERY HOLDDOWN CLAMP



70-77 Maverick & 71-77 Comet
D0DZ10718B...(70-73).....14.50
D4MY10718A...(74-77).....14.50

*****PRICES ARE SUBJECT TO CHANGE*****

See disclaimer on front of catalog. Refer to website for current pricing. Confirm prices upon ordering.

BRAKE SHOE HARDWARE KIT



70-77 Maverick & 71-77 Comet
 Rear
H7048...(70...9" x 1-1/2").....13.00
H7161...(71-77...10" x 1-3/4").....13.00
 Front
H7047...(70...9" x 2-1/4").....13.00
H7154...(71-72...9" x 2-1/4").....13.00
H7160...(73-75...9" or 10").....13.00
H7067...(71-75...10" x 2-1/4").....13.00

REAR BRAKE SPREADER BAR SPRING



70-72 Maverick & 71-72 Comet - 6 cyl
C0DD2601...(yellow).....5.00
 71-75 Maverick & Comet - 250 & 302
C2OZ2601...(red).....3.00

SELF ADJUSTING KITS



70-75 Maverick & 71-75 Comet
H2514...(LH).....15.00
H2515...(RH).....13.00

BRAKE SHOE TO CYLINDER LINK



70-77 Maverick & 71-77 Comet
 Fits 70-75 front and 70-77 rear
B7A2042A...(2 required per wheel...ea).....4.25



Melvin's Classic
 Ford Parts
 PHONE: 770-761-6800



Hardware

REAR BRAKE BACKING PLATE HARDWARE



Fits 70-77 Maverick and 71-77 Comet
 - For attaching backing plate to rear axle
AMK1440...(16 pc).....**21.95**

PARKING BRAKE CABLE CONNECTOR



70-74 Maverick & 71-74 Comet
C6OZ2A790A.....**8.95**

PARKING BRAKE CABLE EQUALIZER



70-77 Maverick & 71-77 Comet
C6OZ2A602A.....**15.00**

PARKING BRAKE CABLE IDLER



70-77 Maverick & 71-77 Comet
C7ZZ2A808B.....**10.00**

PARKING BRAKE EQUALIZER ROD



70-77 Maverick & 71-77 Comet
B7A2628B.....**10.00**

PARKING BRAKE RATCHET PAWL



70 Maverick (will fit 71-75 Maverick & Comet with modification)
OM2786.....**12.00**

PARKING BRAKE RATCHET PAWL SPRING



70 Maverick (Before 1/4/71)
OM2788R.....**4.00**

BRAKE & CLUTCH SHAFT PEDAL BUSHING



70-77 Maverick & 71-77 Comet
B7AZ2471B...(ea...2 Req.).....**1.00**

CLUTCH PEDAL RETURN SPRING



70-77 Maverick & 71-77 Comet
C8OZ7534B.....**29.95**

CLUTCH RELEASE LEVER SPRING



Fork to Equalizer Bar
 70-77 Maverick & 71-77 Comet
 - Correct for 69 Mustang, but closest to the original
C9ZZ7591AR.....**12.95**

CLUTCH ROD RETAINER SPRING



Equalizer Bar to Firewall
 70-77 Maverick & 71-77 Comet
 - Correct for 67 Mustang, but closest to the original
C7ZZ7523AR.....**15.00**

CLUTCH PRESSURE PLATE BOLTS



70-77 Maverick & 71-77 Comet
ARP150-2201.....**14.95**

Hardware

AUTO SHIFT LEVER RELEASE LOCKOUT SPRING



71-76 Maverick & Comet w/Auto Floor Shift
C5ZZ7C300A.....6.00

AUTOMATIC TRANSMISSION FLOOR SHIFT KNOB SET SCREW



PE587..... 0.75

SHIFT COVER HARDWARE



71-74 Maverick & Comet w/ floor shift
AMK1235...(4 pkg).....3.00

SHIFT LEVER / LINKAGE BUSHING



70-77 Maverick & 71-77 Comet
- Used in various locations to secure linkage rods
E0SZ7341B...(ea).....4.95

DASH PAD BOLTS



70-77 Maverick & 71-77 Comet
B11843...(pr).....2.00

DASH PAD NUTS



70-77 Maverick & 71-77 Comet
B11492...(set).....8.50

DOOR HINGE PIN & BUSHING



70-77 Maverick & 71-77 Comet
- Trimming may be required
PE801...(pin)...(ea).....2.25
PE802...(bushing...ea).....1.25

DOOR LATCH SCREWS



70-72 Maverick & 71-72 Comet
AMK653...(stainless steel...6 pkg).....3.95

STRIKER PLATE SCREWS



70-77 Maverick & 71-77 Comet
AMK1135...(4 pkg).....3.50
PE562...(stainless steel...ea).....3.00

DOOR MIRROR SCREWS



70-77 Maverick & 71-77 Comet
- Kit does 2 doors/mirrors, S/S - (10-24 X 1")
B12524...(4 pc).....3.25

SPORT MIRROR - PASSENGER SIDE BASE TO HEAD MOUNTING PLATE HARDWARE

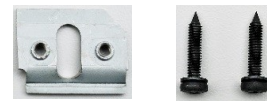

70-77 Maverick & 71-77 Comet
C9AZ17696HDW...(ea).....24.95

ARM REST PAD SCREWS



PE236...(pr).....1.00

Hardware

WINDOW HANDLE SCREW



70-77 Maverick & 71-77 Comet
PE466... (ea).....1.25

MIRROR MOUNTING KIT - NUTSERTS



70-77 Maverick & 71-77 Comet
 - Used in holes on door to secure mirror, compresses and expands on back side when installed properly. Each package contains two screws and two nutserts, enough for one door/mirror.
AMK802... (pkg).....3.25

WINDOW REGULATOR ARM ROLLER



73-77 Maverick & Comet
 - Fits 73-77 4-door & 75-77 2-door
D6AZ5323240A.....12.95

WASHER - SPORT MIRROR RETAINING



70-77 Maverick & 71-77 Comet
 - Used on Drivers side
5298.....5.99

ACCELERATOR RETRACTING SPRING



70 Maverick
C9ZZ9737FR.....19.50

SNORKEL - THERMO DOOR SPRING



71-72 Maverick & Comet
 - For 302 Breather/Cleaner Snorkel Only
C8AZ9A652B.....10.00

AIR CLEANER WING NUTS



70-77 Maverick & 71-77 Comet
383132S... (6 cyl).....2.25
358857... (V8 OEM style).....2.25

AIR CLEANER TO CARB STUD



71-77 Maverick & Comet
 - All w/2 Barrel carburetor
 - 4 1/8 inch long, 5/16 x 18 / 1/4 x 20
370971S.....7.50

ALTERNATOR SPACER



71-73 Maverick & Comet - V8 ONLY
D0OE10A370B... (ea).....11.25

DISTRIBUTOR HOLDDOWN



70-77 Maverick & 71-77 Comet
 - Fits 6 cyl & V8
C5ZZ12270...chrome.....5.95
IM-FE-DC...stainless steel.....18.00



Melvin's Classic
 Ford Parts
 PHONE: 770-761-6800



Hardware

HARMONIC BALANCER - HARDWARE



70-77 Maverick & 71-77 Comet
 AMK1191...(302).....5.00
 AMK281...(6 cyl).....5.00

FREEZE PLUG KIT - BRASS



70-77 Maverick & 71-77 Comet
 381-8015...(V8).....13.95
 381-8013...(6 cyl).....13.95

VALVE COVER BOLTS



70-77 Maverick & 71-77 Comet
 * Includes enough to do one engine
 AMK480...(6 cyl).....7.50
 AMK481...(V8).....12.50

STAINLESS STEEL BOLT SET



- For voltage Regulator & Starter Solenoid Only
 AMK3846...(4 pc).....3.25

ENGINE BRACKET HARDWARE



70-77 Maverick & 71-77 Comet
 - Secures Engine Mount Stand to Frame
 B12112...(pr).....6.25

STARTER BOLT - V8/302



71-77 Maverick & Comet
 AMK1409...(pr).....4.25

THERMOSTAT / WATER NECK HARDWARE



70-77 Maverick & 71-77 Comet
 AMK504...(170/200).....3.68
 AMK505...(250).....3.68
 AMK506...(302).....3.68

EXHAUST MANIFOLD BOLT - HEAT SHIELD



- Used to secure factory heat shield to exhaust manifold
 Sold as a pair
 B12473...(200/250).....6.50
 B12471...(302).....6.50

EXHAUST MANIFOLD BOLTS



AMK526...(200/250...11 pc).....20.00
 AMK527...(302...16 pc).....24.75

SCREW - FOR BODY TRIM



70-77 Maverick & 71-77 Comet
 - Used to secure scuff plates, Quarter window trim (Boomerang)
 B12125...(chrome, stainless steel, wax coated...6 pkg).....3.25

QUARTER EXTENSION STUDS & NUTS



70-73 Maverick & 71-73 Comet
 - fits 2 & 4 door - 1/4-20 x 1 1/2, originals were 1 3/4"
 B12603...(studs...6 pc).....3.50
 B12833...(nuts w/sealer...4 pc).....3.50



Hardware

REAR VALANCE MOUNTING STUD



70-73 Maverick & 71-73 Comet
PE275...(pr).....4.00

REAR VALANCE SCREWS



- Stainless steel, chrome plated
 70-73 Maverick & 71-73 Comet
B11175...(6 pc).....4.00

LICENSE PLATE SCREWS & NUTS



PE197...(8 pc).....2.25

LICENSE LIGHT HARDWARE



70-73 Maverick & 71-73 Comet
 -Secures rear license lamp assembly to rear bumper
AMK448...(pr).....1.50

NUT - FOR MOLDING CLIP



70-77 Maverick & 71-77 Comet
 - Comes in a package of 4 nuts per bag
B12955...(size 10-24, all molding clips except clip #B13151).....4.25
B12941...(size 8-32, for molding clip # B13151).....3.25

SCREW - FOR BODY TRIM



70-77 Maverick & 71-77 Comet
 - Used to secure the following moldings: hood and trunk, lower corners of front windshield, lower rear windshield, quarter panel extension and wheelwell.
AMK1636...(stainless steel, wax coated...28 pkg).....10.00

SCREW - FOR MOLDING CLIP MOUNTING



70-77 Maverick & 71-77 Comet
 Special phillips flat head screw used to replace broken/missing welded studs used to secure molding clips. Size #4-24 x 3/8"
 7/32" Head diameter
RJL9877...(10 pkg).....3.00

SCREW KIT - EXTERIOR



75 Maverick & Comet
FO1785...(11 pc - w/o wheel well mldg. screws).....6.50
FO1785A...(39 pc - includes wheel well mldg. screws).....18.95

BODY BOLT



70-77 Maverick & 71-77 Comet
B10379-S7...(cadmium-star washer-"HTS"...12 pc).....10.50
B11354-S2...(gray-black 5/16"-18 x 15/16" 1/2"...12 pc).....10.50
B10782-S7...(cadmium "Flag" 5/16"-18 x 15/16" 1/2"...12 pc).....10.50
378178SS...(stainless steel...12 pc).....21.95

CHIN SPOILER HARDWARE KIT



AMK976.....7.25

BUSINESS HOURS
TUES-FRI 8:30-5:00
SATURDAY 8:30-2:00
CLOSED SUNDAY AND
MONDAY
EASTERN STANDARD TIME

VISIT US ON THE WEB AT:
WWW.MELVINSCLASSICFORDPARTS.COM

Hardware

U-NUT - FENDER APRON



70-77 Maverick & 71-77 Comet
PE119...(12 pkg).....7.00

U-NUT & BOLT - FRONT VALANCE



70-77 Maverick & 71-77 Comet
10053...(u-nut...ea)......50
9480...(bolt...ea)......60

U-NUT - REAR BUMPER BRACKET



70-73 Maverick & 71-73 Comet
B12013...(2 pc).....8.00

BUMPER BOLTS - w/STAINLESS CAP



70-72 Maverick & 71-72 Comet - Front & Rear Bumpers & 73 Rear
 Bumper on Mavericks & Comets
B12761...(7/16"-14 x 1 1/4" ...ea).....2.00

70-72 Maverick & 71-72 Comet - Secure ends of Front Bumper
9854...(5/16" - 18 x 3/4" ...ea)......99

74-77 Maverick & Comet Front & Rear Bumpers
 & 73 Front Bumper on Mavericks & Comets
**5242...(7/16"-14 x
 1 1/2" ...ea).....2.00**

BUMPER BOLT NUTS & WAVE WASHERS - FOR USE w/BUMPER BOLTS



14877...(nut...ea)......59
MM013A...(wave washers...8 pkg).....6.50

HOOD LEVELER



70-77 Maverick & 71-77 Comet
 - Located on Radiator Support for Hood Bumpers
B12036...(pr).....6.00

COMET GT HOOD SCOOP - HARDWARE



71-75 Comet GT - (each scoop requires 10 studs/nuts)
B13780...(3 studs).....5.95
B950...(4 nuts).....4.25

GRABBER HOOD SCOOPS - HARDWARE



71-72 Maverick
 5/32" Acorn Flange Palnut w/Sealant
 - (6 per kit, Does Both Sides)
B12973...(6 pkg).....3.50

FUEL FILLER PIPE SCREWS



70-77 Maverick & 71-77 Comet
AMK413...(5 pkg).....3.50

FILLER PIPE SEAL SCREWS



70-77 Maverick & 71-77 Comet
AMK992.....3.50



**Melvin's Classic
 Ford Parts
 PHONE: 770-761-6800**



Hardware

FUEL TANK STRAPS



76-77 Maverick & Comet
 - For use with F30 fuel tank above or to replace damaged straps on 76-77 models...if installing F30 Fuel tank in 71-75, longer bolts can be used instead of buying these straps...your decision. Longer bolts are NOT sold by Melvin's Classic Ford Parts. We recommend using the longer straps designed for the tank.
ST99.....39.95

FUEL TANK STRAP MOUNTING BOLTS



71-77 Maverick & Comet
 - Used to fasten straps under Fuel tank to vehicle- Will not work if using 71-75 straps to secure a 76-77 Fuel Tank
AMK1411...(pr).....6.75

HEATER ASSEMBLY TO FIREWALL - NUTS



70-77 Maverick & 71-77 Comet
AMK1780...(8 pc).....6.00

HEATER HOSE CLAMPS



70-77 Maverick & 71-77 Comet
AMK383...(6 pc).....12.00

SEAT BACK HARDWARE



71-73 Maverick & Comet
 - With Hi-Back Bucket Seats – Secures Plastic Back to Seat
 1 set does both seats
AMK3768...(set).....3.50

SCREW KIT - INTERIOR



EXAMPLE - FOR REFERENCE ONLY



EXAMPLE - FOR REFERENCE ONLY

FO1600...(70 - 72 dr...46 pc).....18.95
FO1786...(74-75 4 dr...63 pc).....29.95

UPHOLSTERY HOG RING



- Sold in packages of approximately 100
PE168...(pkg).....2.00

FRONT SEAT TRACK LATCH SPRING



70-72 Maverick
C0DB6461883C...(3"...pr).....8.00

BOLT - SEAT BELT



70-73 Maverick & 71-73 Comet
B10152...(shoulder harness...ea).....6.25
B10434...(front seat belt - inboard & outboard...pr).....8.50

DIMMER SWITCH SCREWS



70-77 Maverick & 71-77 Comet
AMK740...(wax coated).....2.25

STEERING WHEEL NUT



70-77 Maverick & 71-77 Comet
B10014...(ea).....2.50

Hardware

HEADLAMP ADJUSTING KIT



70-77 Maverick & 71-77 Comet
 AMK3990...(before 8/12/74).....20.00
 AMK3992...(after 8/12/74).....20.00

HEADLIGHT DOOR SCREW



70-77 Maverick & 71-77 Comet
 9405...(#8 x 1" ...s/s...ea)..... .65

HEADLAMP SPRINGS



70-74 Maverick & 71-74 Comet
 C6AZ13031C...(70 only).....2.25
 C2OZ13031A...(71-74).....2.50

HEADLIGHT DOOR NUT



70-77 Maverick & 71-77 Comet
 9862...(ea)..... .50

HEADLIGHT DOOR MOUNTING KIT



70-77 Maverick & 71-77 Comet
 MM019...(6 pc).....4.00

HEADLIGHT BUCKET BEARING / ANTIRATTLE



75-77 Maverick & Comet
 - 1 kit does both sides
 D5UZ13B160B...(6 pc).....7.00

RADIATOR HOSE CLAMP



70-77 Maverick & 71-77 Comet
 B13106...(1 3/4" ...2 pc).....8.50
 B13107...(2" ...2 pc).....8.50

FAN SHROUD HARDWARE



73-77 Maverick & Comet
 AMK403.....6.75

CAM BOLT & NUT KIT



70-77 Maverick & 71-77 Comet (kit does 1 vehicle)
 AMK1515...(kit).....25.00

PITTMAN ARM TO STEERING SECTOR NUT



70-77 Maverick & 71-77 Comet
 - All with 1-1/8 diameter shaft size (1.125)
 B12805.....2.95

POWER STEERING BRACKET SPACER

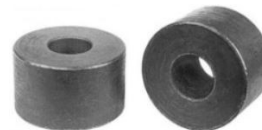

71-77 Maverick & Comet
 B13195...(ea).....6.50



**Melvin's Classic
 Ford Parts
 PHONE: 770-761-6800**



Hardware

POWER STEERING CYLINDER BRACKET TO FRAME CRUSH NUT



70-77 Maverick & 71-77 Comet
 - Inserts into frame and crushes upon tightening bolt to secure
 Bracket to frame. 2 Required
375474S8...(ea).....3.50

STEERING GEARBOX WASHER



70-77 Maverick & 71-77 Comet
B13024...(3 pkg).....4.25

UPPER CONTROL ARM SHAFT BOLT



70-72 Maverick & 71-72 Comet
B10125...(pr).....8.25

UPPER CONTROL ARM SHAFT BOLT NUTS



- Secures upper control arm shaft bolt to vehicle
 70-77 Maverick & 71-77 Comet
B12798...(4 pc).....3.50

STRUT ROD TO BODY HARDWARE



70-77 Maverick & 71-77 Comet
AMK659...(4 pc).....11.25

FRONT CROSSMEMBER BOLTS



70-77 Maverick & 71-77 Comet w/V8
AMK1280...(pr).....11.25

SHOCK TOWER CAP NUT AND BOLT SET



70-77 Maverick & 71-77 Comet
AMK313...(6 pc).....11.25

DIFFERENTIAL CARRIER WASHERS



71-77 Maverick & 71-77 Comet
AMK1165...(10 pc).....5.00

DIFFERENTIAL PINION NUT



70-77 Maverick & 71-77 Comet
B10471.....5.25



Hardware

DRIVE SHAFT U-BOLT - (For 1-1/8 Bearing Caps)



70 to 5/1/72 Maverick & 71 to 5/1/72 Comet
C1AZ4529A...(5/16-24...pr).....8.95
 72-77 Maverick & Comet (after 5/1/72)
D3AZ4529C...(5/16-18...ea).....4.95

REAR AXLE VENT



70-77 Maverick & 71-77 Comet
 - Vents axle and secures rear brake hose to differential
 - This part will not fit some 75 models
B10335...(2 1/8" x 7/16-20).....12.00

REAR LEAF SPRING CENTERING BOLTS



70-77 Maverick & 71-77 Comet
B10222...(pr).....8.25

REAR SHOCK UPPER MOUNT BOLT



71-77 Maverick & Comet - (Must re-use OEM spacer)
B13375...(1/2"-13 x 2 3/4"...pr).....10.00
B12797...(nut...6 pkg).....5.00

REAR SPRING BUSHING BOLT



70-77 Maverick & 71-77 Comet
35185...(ea).....15.95

REAR SPRING U-BOLT



70-74 Maverick & 71-74 Comet (7/16" x 3 1/4" x 6")
AMK3441...(12 pc).....26.95
 75-77 Maverick & Comet (7/16" x 2 1/2 x 6 1/8")
D5DZ5705A...(ea).....10.95

UPPER CONTROL ARM GREASE FITTING KIT



- Special zerck fittings with extra long extensions. Helps solve squeaky upper control arms. Installation tool included.
 70-77 Maverick & 71-77 Comet
374714SK...(ea).....16.95

LUG NUTS



- For Magnum 500 Wheels-
C9ZZ1012...(w/ s/s cap...ea).....1.85
 - For Standard Wheel
8744...(standard...ea)......65



Melvin's Classic
 Ford Parts
 PHONE: 770-761-6800



Hardware

WHEEL STUDS



70-77 Maverick & 71-77 Comet

- Rear
 27832B...(70-73).....CALL
 6184B...(74-75).....CALL
 27856B...(76-77).....CALL

- Front
 27781B...(70-73).....CALL
 27833B...(74-77).....CALL

FLYWHEEL/FLEXPLATE BOLTS



70-77 Maverick & 71-77 Comet
 AMK1839...(7/16"-20 x 15/16" - w/ manual trans.).....15.75
 AMK1839...(7/16"-20 x 15/16" - C4 w/reinforcement ring).....15.75
 AMK1840...(7/16"-20 x 3/4" - C4 w/o reinforcement ring).....15.75

TORQUE CONVERTER FLANGE NUTS



x4

70-77 Maverick & 71-77 Comet
 - Secures Torque Converter to Flex Plate
 AMK185...(4 pc).....5.00

TRANSMISSION OIL COOLER LINE FITTINGS



70-77 Maverick & 71-77 Comet
 359279S...(pr).....6.50

TRANSMISSION OIL PAN BOLTS



x11

70-77 Maverick & 71-77 Comet w/C4
 AMK1621...(11 pc).....5.00

KICK DOWN CONTROL SHAFT SPRING



70-77 Maverick & 71-77 Comet
 D1AZ7146...(ea).....8.00

SPEEDOMETER CABLE TO TRANS. CLAMP



70-77 Maverick & 71-77 Comet
 - Secures speedometer cable to transmission
 B9TZ17264.....5.00

SPARE TIRE MOUNTING NUT & J BOLT



70-77 Maverick & 71-77 Comet
 C8AZ1462A...(nut).....3.00
 C9ZZ1448B...(j-bolt).....15.00

WIPER WASHER NOZZLE SCREWS



70-77 Maverick & 71-77 Comet
 Also used to secure washer "F" to firewall
 AMK855...ea.....1.00



BUSINESS HOURS
TUES-FRI 8:30-5:00
SATURDAY 8:30-2:00
CLOSED SUNDAY AND
MONDAY
EASTERN STANDARD TIME

Heater

HEATER ASSEMBLY



70 Maverick – correct unit used until 8/25/69.
 - This heater assembly required use of a 61” long Defroster control Cable from factory until 8/25/69, at which time the assembly changed as did the cable length required for defroster function.
C9ZZ18A542K...(w/o AC).....325.00

HEATER ASSEMBLY TO FIREWALL - NUTS



70-77 Maverick & 71-77 Comet
AMK1780...(8 pc).....6.00

HEATER CORE



70-77 Maverick & 71-77 Comet
HRT9033...(without AC).....60.00
HRT9032...(with integral AC).....60.00

HEATER CORE END CAPS



70-77 Maverick & 71-77 Comet
C7ZZ18500C...w/integral AC...(2 pc).....10.95

HEATER BOX CLIP



70-77 Maverick & 71-77 Comet
C0DF19A779A...(ea).....2.50

**VISIT US ON THE WEB AT:
WWW.MELVINSCLASSICFORDPARTS.COM**

HEATER BOX SEAL KIT - (Kit Includes Inlet Gasket)



70-77 Maverick & 71-77 Comet
M204...(kit).....12.95

FRESH AIR/HEATER/AC - INLET GASKET



70-77 Maverick & 71-77 Comet
C5ZZ18A569A...(inlet gasket only).....5.00

HEATER BLOWER MOTOR



70 Maverick
35540...(w/o AC).....59.95
 71-77 Maverick & Comet
35502...(w/o AC).....49.95

BLOWER MOTOR WHEEL



70-77 Maverick & 71-77 Comet
35611...(w/o AC).....55.00

HEATER SWITCH TO BLOWER MOTOR RESISTOR ASSEMBLY



70-75 Maverick & 71-75 Comet
C8OZ18591A...(heater only).....22.00



**Melvin's Classic
 Ford Parts
 PHONE: 770-761-6800**



Heater

NYLON RIVET



70-77 Maverick & 71-77 Comet
 - Used to secure resistor assembly and defroster duct to heater box
375064S...(ea).....75

HEATER HOSE THROUGH FIREWALL GROMMETS



70-77 Maverick & 71-77 Comet
382745...(pr).....15.00

HEATER HOSE



70 Maverick - All before 2/1/70
HH3...(red stripe).....40.00
HH3AC...(red stripe w/AC).....49.00
 70 Maverick - All after 2/1/70
HH6...(yellow stripe).....40.00
HH6AC...(yellow stripe w/AC).....49.00
 71 Maverick & Comet
HH7...(yellow stripe).....40.00
HH7AC...(yellow stripe w/AC).....49.00
 72 Maverick & Comet
HH9...(yellow stripe).....40.00
HH9AC...(yellow stripe w/AC).....49.00
 73 Maverick & Comet
HH10...(yellow stripe).....40.00
HH10AC...(yellow stripe w/AC).....49.00

HEATER HOSE CLAMPS



70-77 Maverick & 71-77 Comet
AMK383...(6 pc).....12.00



HEATER - TEMPERATURE CONTROL CABLE



70-77 Maverick & 71-77 Comet
 - This cable is correct for 73-79 Ford Trucks. Factory Maverick cable measures 43 1/8". This cable measures 43 1/4".
D3TZ18518B...(w/o AC).....20.00

HEATER - DEFROSTER CONTROL CABLE



8/25/69 -77 Maverick & 71-77 Comet
 - This cable is correct for 73-79 Ford Trucks. Factory Maverick cable measures 32". This cable measures 31 1/2".
D3TZ18552A...(w/o AC).....17.00

CABLE CLAMP & SCREW



70-77 Maverick & 71-77 Comet
 - Secures heater/defrost cables
PE373.....6.00

HEATER CONTROL KNOBS



70-77 Maverick & 71-77 Comet
 - These are for 69-70 Mustangs, but look and work great! Comes as a set of 3, you will need to order 2 kits if your application has a rear window defogger to obtain the additional knob.
C9ZZ18519K...(3 pkg).....16.85



Interior

ASH TRAY - REAR QUARTER



- This is correct for 69-70 Mustangs. It features a Bright bezel with a textured black door face. This mounts on the side of the rear quarter, NOT in the armrest section of the rear quarter.
74-77 Maverick & Comet
C8AZ6262876A...(ea).....30.00

CARPET - 2 Door - (Add \$25.00 for Shipping)



70-77 Maverick & 71-77 Comet
- Available in: Black, Blue, Bright Red, Charcoal Gray, Dk. Blue, Dk. Green, Ginger, Ivy Gold, Maroon & Moss Green.
CARMAV2.....195.00

CARPET - 4 Door - (Add \$25.00 for Shipping)



70-77 Maverick & 71-77 Comet
- Available in: Black, Bright Red, Charcoal Gray, Dk. Blue, Ginger, Ivy Gold & Maroon.
CARMAV4.....195.00

DIMMER SWITCH COVER



70-77 Maverick & 71-77 Comet
C5ZZ13533A.....5.00

DIMMER SWITCH GROMMET



70-77 Maverick & 71-77 Comet
MM018.....3.00

FLOOR MATS - (Add \$20.00 for Shipping)

- Universal, will fit 70-77 Maverick & 71-77 Comet
- Available in Aqua, Black, Dk. Blue, Gray, Ivy Gold, Maroon, Med. Blue, Red and Saddle. - Embroidery of "Maverick" or "Comet" available in Black, White, Red, Blue or Silver on FRONT MATS ONLY.

*** SPECIFY COLOR OF MAT AND LOGO WHEN ORDERING**

PLAIN - NO LOGO - (Add \$20.00 for Shipping)

Maverick / Comet...(4 pc).....89.95

WITH EMBROIDERY - (Add \$20.00 for Shipping)



"Maverick" on front mats only...(4 pc).....130.00

"Comet" on front mats only...(4 pc).....130.00

COAT HOOK RELATED



70-77 Maverick & 71-77 Comet
C8AZ6229024...(black cover...ea).....5.25
C8AZ6229232A...(plastic retainer...ea).....4.00

DOME LIGHT BEZEL



70-77 Maverick & 71-77 Comet
D0AZ13788A...(Before 6/1/71).....15.00
D1AZ13788A...(After 6/1/71).....20.00

DOME LIGHT LENS



70-77 Maverick & 71-77 Comet
C60Z13783A...(70 to early 71 only).....10.50
D1AZ13783B...(71-77).....8.50
D2LY13783E...(72-77...w/map light).....18.00

Interior

HEADLINER - (TIER GRAIN ONLY)



70-77 Maverick & 71-77 Comet - (2 Door Models)
 - Available in Black, Bright Red, Dk. Blue, Ginger, Green, Lt. Blue, Lt. Gray, Maroon, Med. Blue, Turquoise and White.
Please specify color when ordering
HLMAV62.....80.00

70-77 Maverick & 71-77 Comet - (4 Door Models)
 - Available in Black, Bright Red, Dk. Blue, Ginger, Green, Lt. Blue, Lt. Gray, Maroon, Med. Blue, Turquoise and White.
Please specify color when ordering
HLMAV54.....80.00

HEADLINER ROD RETAINERS



70-77 Maverick & 71-77 Comet
 - Attaches to roof and holds the rear headliner rod in place
C5ZZ6342180...(2-door only...pr).....9.95

FIREWALL INSULATOR PAD



71-77 Maverick & Comet
 - Pre-molded, Ready to Install
MAV7077-C.....194.95

FIREWALL PAD



- Universal 20" x 65" Rubber with Jute backing
UNI-710.....40.00

TRUNK DIVIDER - (Oversize S/H)



70-77 Maverick & 71-77 Comet
FAM-182.....18.00
TKD-025...(luxury decor w/jute).....40.00

INSULATION, FOIL BACK



48" x 72" -Jute
INSULATIONSGL...(roll).....48.95

INSULATION SELF ADHESIVE



- 36" x 50", Great for sound proofing, heat resistant, waterproof deadener, installs under headliner, inside door panels, firewall ETC. Peel and Stick
B5010FSS...(roll).....38.00

PACKAGE TRAY - (Oversize S/H)



70-77 Maverick & 71-77 Comet
 * SPECIAL ORDER - Allow 3-4 weeks for delivery
FAM-102...(Black - 2 dr w/o speaker holes).....35.00
FAM-108...(Black - 4 dr w/o speaker holes).....35.00

PACKAGE TRAY RETAINERS



70-77 Maverick & 71-77 Comet
 Can use factory screws or secure with provided clips
C4AZ6246698K...(pr).....8.95

PACKAGE TRAY INSULATION



70-77 Maverick & 71-77 Comet
FAM-121...(2 dr).....20.00
FAM-122...(4 dr).....20.00

SAIL PANEL INSULATION



70-77 Maverick & 71-77 Comet
FAM-720.....15.00

Interior

STEERING WHEEL - UNIVERSAL BY GRANT



- GR968...(black foam grip).....129.95
- GR966-0...(wood).....149.95
- GR966...(wood).....149.95

STEERING WHEEL ADAPTER KIT



- Universal for Grant Steering Wheels
GR3249.....30.00

STEERING WHEEL



- 70-77 Maverick & Comet
- D0AZ3600K...(70-74...black, exact repro).....295.00
- D8TZ3600B...(75-77...black, correct for 80-86 Ford Trucks)....315.00

STEERING WHEEL - 70 Non locking column ONLY



- 70 Maverick ONLY
- C8ZZ available in Black, Blue, Ivy Gold or Tan
- C8ZZ3600...(2 spoke).....195.00
- C9ZZ3600WG...(wood grain 3 spoke rimblow).....600.00

HORN RING



- 70 Maverick ONLY - For Use with above Steering Wheel
- Used until 8/25/69
- C9AZ13A805B.....55.00

HORN PAD



- 70-74 Maverick & 71-74 Comet
- C9ZZ3623...(70 w/o locking column deluxe 3-spoke st. wheel).....85.00
- D0ZZ3623...(for 70-74 deluxe 3-spoke steering wheel).....80.00
- D0AZ3623...(fits 2-spoke steering wheel).....69.95

HORN SWITCH TRIM PLATE - WOODGRAIN



- 71-74 Maverick & Comet
- Fits 2-Spoke **Deluxe** Steering Wheel Horn Pad
- D1ZZ13932.....42.00

HORN PAD - With "FORD" Logo



- 75-77 Maverick & Comet (Correct for 1980-86 Ford Trucks)
- E0TZ13A805E...(black w/woodgrain).....145.00
- E7UZ13A805A...(black).....115.00

SPORT STEERING WHEEL HORN BUTTON & EMBLEM



- 77 Maverick
- Will fit any year Maverick or Comet with added "Sport" Steering Wheel
- D8TZ13A805BL...(black outer ring).....85.00
- D8TZ13A805A...(silver outer ring).....85.00

RIM BLOW HORN SWITCH



- 70-73 Maverick & 71-73 Comet
- With 3-spoke steering wheel
- D1AZ13A875A.....135.00

Interior

HORN PAD COVER



70 Maverick W/O locking column - 3 Spoke w/Rim Blow
C9ZZ3752.....130.00

ALUMINUM INSERTS & PLASTIC TRIM

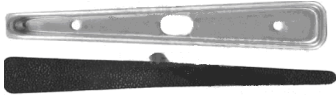

70-73 Maverick & 71-73 Comet w/ Rim Blow Steering Wheel
D0ZZ3623INS...(6 pc).....80.00

HORN PAD EMBLEM



70-77 Maverick & 71-77 Comet
D8TZ3649A...(fits 77 sport steering wheel horn button).....25.00
C9AZ3627...(1970 non-locking column deluxe 3-spoke pad)....40.00
D0AZ3627...(for 70-74 deluxe 3-spoke pad).....40.00

HORN SWITCH GAP COVER FOR RIMBLOW



70-73 Maverick & 71-73 Comet
 - Fits in groove at bottom of steering wheel
D1AZ13875C...(ea).....13.50

HORN BUTTON COVER



- For Grant Steering Wheels
GR5894...(plain).....6.95
GR5685...(w/Ford logo).....18.00



HORN SWITCH



70-74 Maverick & 71-74 Comet w/ Standard or Deluxe Steering Wheel
D2AZ13A875A.....105.00

HORN SWITCH COVER



71-74 Maverick & Comet
D0ZZ13915...(for standard 2-spoke w/locking column).....36.95
D1ZZ13915...(for deluxe 2-spoke w/locking column).....36.95

SHIFT SELECTOR LENS - COLUMN MOUNTED



70 Maverick - w/Non-Locking Column ONLY
C8SZ7B037A.....20.00

STEERING WHEEL NUT



70-77 Maverick & 71-77 Comet
B10014...(ea).....2.50

SCUFF PLATE - LABELS SOLD SEPERATELY



70-73 Maverick & 71-73 Comet - (2 Door Models)
 Will fit 74-77, 2 holes will have to be drilled
D0DZ6213208...(70 Maverick...pr).....139.95
SP05...(ea).....18.00
SP05SS...(stainless...pr).....99.00
PE397...(scuff plate screws...12 pc).....3.25

SCUFF PLATE LABEL



71-77 Maverick & Comet
DF709...(Blue Ford Oval...ea).....2.00

**VISIT US ON THE WEB AT:
WWW.MELVINSCLASSICFORDPARTS.COM**

Interior

SUNVISORS



70-77 Maverick & 71-77 Comet
 * Mustang visor has one corner different from Maverick
HT71...(correct for 71-73 Mustang*...pr).....55.00
 - OEM Replacement, available in Black, Dk. Blue, Green, Lt. Blue,
 Maroon, Med. Blue, Red, Turquoise and White.
 Specify color when ordering
MAVSUNVISOR.....95.00

ARM AND BRACKET ASSEMBLY - SUNVISOR



70-75 Maverick & 71-75 Comet
 - Before 10/1/75
D1ZZ6204144A...(ea).....30.00
MM015...(screws...6 pc).....2.25

SUNVISOR TIP



70-77 Maverick & 71-77 Comet
PE115...(pr).....1.50

SUNVISOR ANCHOR PIN



1970 Maverick Only - Anchor Pin Only-
C4SZ6304114A...(chrome...ea).....3.00
 71-77 Maverick & Comet
D3AZ6504144B...(ea).....3.75

SUNVISOR CENTER CLIP



70-77 Maverick & 71-77 Comet
C8ZZ6504132BLK.....15.75
C8ZZ6504132WH.....15.75
MM026...(screws 2 pc).....1.00



BUCKET SEAT UPHOLSTERY



71-73 Maverick & Comet
 - Correct pattern for 71-73 Mach I Mustang.
069054-3722...(black...pr).....325.00
069054-3788...(blue...pr).....325.00
069054-4061...(ginger...pr).....325.00
069054-4234...(green...pr).....325.00
069054-4063...(vermillion...pr).....325.00
069054-4062...(white-silver...pr).....325.00

Interior

SEAT BACK



- 71 Maverick & Comet w/Hi Back Buckets
D1ZZ6560762...(pr).....99.00
- 72-73 Maverick & Comet w/Hi Back Buckets
D2ZZ6560762...(pr).....99.00

SEAT BACK HARDWARE



- 71-73 Maverick & Comet
 - With Hi-Back Bucket Seats - Secures Plastic Back to Seat
 1 set does both seats
AMK3768...(set).....3.50

SEAT ADJUSTING KNOB



- 70-77 Maverick & 71-77 Comet -All Bench and Bucket Seats
C5AZ6261753...(black plastic...ea).....5.00
C5AZ626060A...(knob retainer...ea).....3.50

SEAT HINGE COVERS



- 70-73 Maverick & 71-73 Comet w/Hi Back Buckets
 - Requires two (2) pair per vehicle
D1ZZ6561692...(pr).....24.95

SEAT LATCH RELEASE HANDLES



- 71 Maverick & Comet w/Hi Back Buckets
D1FZ6262622A...(pr).....35.00
- 72-73 Maverick & Comet w/Hi Back Buckets
D1FZ6262622B...(pr).....35.00

SPRING - FRONT SEAT TRACK LATCH



- 70-72 Maverick
C0DB6461883C...(3"...pr).....8.00

SEAT FOAM - AMERICAN CUSHION IND.



- The best fitting foam in the industry. Concours
 Quality professional grade.
MAVSEATBUN...(ea).....140.00

SEAT BELTS



- Universal 74" w/chrome lift buckle & mounting hardware
 Available in Black, Blue, Bright Red, Dk Blue, Dk Gray, Dk Red,
 Green, Maroon & Tan.
SEATBELT...(specify color when ordering).....28.00

SEAT BELT BUTTON DECAL



- 70-72 Maverick & 71-72 Comet
DF1523...(ea).....6.00

SEAT BELT BUCKLE RESTORATION KIT



- 70 Maverick w/Deluxe Interior
C8AZ65611A72K...(kit).....35.00

**VISIT US ON THE WEB AT:
 WWW.MELVINSCLASSICFORDPARTS.COM**

Interior

SEAT BELT RETRACTORS



Universal
64F43192M...(pr).....25.00

SEAT BELT SHOULDER HARNESS BOLT COVER



70-73 Maverick & 71-73 Comet
D0ZZ6560234...(70-71...pr).....24.95
D1AZ6560235...(72-73...ea).....14.95

HEADREST



1970 Maverick Only
3641RL...(ea).....80.00

HEADREST GUIDE & RETAINER



70-72 Maverick & 71-72 Comet
- For mounting headrest to full bench seat built before 8/21/72
3641RM...(ea).....25.00

STARTING INSTRUCTION SLEEVE



Maverick & Comet
DF1508...(1974).....5.50
DF1507...(1976).....5.50

TURN SIGNAL LEVER



70-77 Maverick & 71-77 Comet
C7ZZ13305A...(w/chrome knob).....10.00
D3TZ13305B...(w/black knob).....25.00

ACCELERATOR PEDAL



71-77 Maverick & Comet
- Correct for Mustang. Measures 5 1/4", original measures 6 1/2".
Mounts the same, you will have to shorten your spring.
D1ZZ9735.....18.95

KICK PANELS



70-72 Maverick & Comet
- Reproduction. Two (2) new holes may need to be drilled
into metal behind kick panels.
KP-MAV.....89.95



UPS NEXT DAY & 2nd DAY AIR AVAILABLE

Interior

INSTRUMENT BEZEL LENS



70-77 Maverick & 71-77 Comet
 Note, This lens set is for a 69-70 Mustang, the center piece is all you will need for your application
C9ZZ10887A.....42.00

GLOVE BOX LINER



74-77 Maverick & 74-77 Comet
FAM-063...(w/o AC).....20.00
MA102...(w/AC).....20.00
PE196...(screws 8 pc).....2.25

SPORTLAMP TOGGLE SWITCH KNOB



71-72 Maverick
41876-A.....9.95

GLOVE BOX BUMPERS



73-77 Maverick & Comet
PE120...(pr).....1.50

ASH TRAY BUMPER



70-77 Maverick & 71-77 Comet
358159A2S...(ea).....3.00

DASH PAD COVER/CAP - (**Oversize S/H**)



70-77 Maverick & 71-77 Comet
 - Black Only - Can be painted to match
DASH405.....119.95

DASH PAD NUTS



70-77 Maverick & 71-77 Comet
B11492...(set).....8.50

DASH PAD BOLTS



70-77 Maverick & 71-77 Comet
B11843...(pr).....2.00

DOOR PANELS - REPRODUCTION



- Quality reproduction
 Each panel will fit any year, you remove perforated cut-outs for your application. See website for available colors.
 70-77 Maverick & 71-77 Comet
063052...(Standard, no chrome).....315.00
630XX...(Top - Basketweave w/chrome mylar).....Coming Soon
063054...(Top - Woodgrain, w/chrome mylar).....325.00
063056...(Luxury Décor).....325.00
063058...("L" shaped woodgrain, w/chrome mylar).....325.00
063060...(Standard w/chrome mylar).....325.00

DOOR PANEL BOARDS



70-77 Maverick & 71-77 Comet
 - Perfect for making custom door panels
FAM-042...(pr).....69.95

DOOR PANEL CLIPS



70-77 Maverick & 71-77 Comet
PE150...(15 pkg).....3.50



Interior

ARMREST / PULL HANDLE



- Correct for 81-86 Mustangs, closest on market to the original, does NOT have chrome bezel at top like factory original. Available in Black or White

24140-15243...(late 73-77...black).....89.95
 24140-15103...(late 73-77...white).....99.95

ARMREST PADS



70-73 Maverick & 71-73 Comet
 - Deluxe available in Black, Blue, White & Ginger
 Must Specify Color & LH or RH side when ordering Deluxe

D1ZZ6524...(deluxe interior...ea).....31.50
 AR101CB...(70-73 standard interior...ea...blue).....40.00
 AR101C...(70-73 standard interior...ea...black).....40.00

ARMREST BASE



70-72 Maverick & 71-72 Comet
 Fits Deluxe Arm rest pad, Black Only

D3DZ6224144...(deluxe interior...ea).....20.00

ARM REST PAD SCREWS



PE236...(pr).....1.00

ARMREST CLIP



70-73 Maverick & 71-73 Comet w/o Molded Arm rest

C6AZ6224146EA...(ea).....2.00
 C6AZ6224146B...(6 pk).....21.95

DOOR HANDLES -INSIDE



70-72 Maverick & 71-72 Comet

D1AZ6522601...(LH...ea).....20.00
 D1AZ6522600...(RH...ea).....20.00

WINDOW HANDLES



70-77 Maverick & 71-77 Comet 2-Door Models

C8AZ6223342A...(before 7/21/69).....11.00
 C9UZ8223342A...(7/21/69 to 10/1/71).....12.00
 D2OZ6523342A...(10/1/71 to 4/2/73).....25.00

73-77 Maverick & 73-77 Comet 2 & 4 -Door Models

D3AZ6523342A...(after 4/2/73 w/clear knob).....10.50
 D3AZ6523342BLK...(after 4/2/73 w/black knob).....10.50

WINDOW HANDLE KNOBS



70-77 Maverick & 71-77 Comet

C8AZ6223352GL...(ginger).....8.00
 23352BLK...(black).....5.00
 C8AZ6223352MR...(maroon).....8.00
 C8AZ6223352PR...(parchment).....8.00
 C8AZ6223352VE...(vermillion - bright red).....8.00
 C8AZ6223352WT...(white).....8.00
 C8AZ6223352BL...(blue).....8.00
 C8AZ6223352GR...(green).....8.00
 C8AZ6223352IG...(ivy gold).....8.00
 23352CLR...(clear).....5.00

WINDOW HANDLE SCREW



70-77 Maverick & 71-77 Comet

PE466...(pr).....1.25

WINDOW HANDLE SCREW COVER



70-77 Maverick & 71-77 Comet

PE426...(aluminum discs...pr).....3.25

WINDOW HANDLE ESCUTCHEON



70-77 Maverick & 71-77 Comet

PE465...(plastic discs...pr).....2.00

BULB - (INSTRUMENT CLUSTER)



70-77 Maverick & 71-77 Comet
 - All bulbs within cluster, same bulb
 194...(ea).....1.00

BULB - (FRONT & REAR SIDE MARKERS)



70-77 Maverick & 71-77 Comet
 161...(All except 73 Comet front markers...ea).....2.25
 194...(73 Comet front markers only...ea).....1.00

BULB - (TRUNK)



70-77 Maverick & 71-77 Comet
 631...(70-74...ea).....2.00
 1178...(75...ea).....1.65
 89...(76-77...ea).....1.00

BULB - (COURTESY - UNDER DASH)



74-77 Maverick & Comet
 631...(74...ea).....2.00
 1178...(75...ea).....1.65
 89...(76-77...ea).....1.00

BULB - (PARKING, TURN, TAIL/STOP)



70-77 Maverick & 71-77 Comet
 1157...(ea).....1.25
 1157A...(amber...ea).....2.50

BULB - (ASH TRAY)



70-77 Maverick & 71-77 Comet
 1445...(ea).....1.35

BULB - (HEATER, A/C CONTROL)



70-77 Maverick & 71-77 Comet
 1895...(70-71 Maverick, 71 Comet...ea).....1.25
 1445...(72-77...ea).....1.35

BULB - (BACK-UP LAMP)



70-77 Maverick
 1157...(70-72...ea).....1.25
 1156...(74-77...ea).....2.00
 75-77 Comet
 1156...(75-77...ea).....2.00

BULB - (LICENSE PLATE LAMP)



70-77 Maverick & 71-77 Comet
 97...(70-73...ea).....1.25
 1178...(74-77...ea).....1.65

BULB - (CONSOLETTE CLOCK)



71-74 Maverick & Comet
 1895...(71-72...ea).....1.25
 1816...(73-74...ea).....1.50

BULB - (TRANS. SHIFT INDICATOR)



70-77 Maverick & 71-77 Comet
 1445...(ea).....1.35

BULB - (HEATER - A/C CONTROL)



70-77 Maverick & 71-77 Comet
 1445...(ea).....1.35

BULB - (RADIO PILOT)



70-77 Maverick & 71-77 Comet
 1893...(ea).....1.50



**Melvin's Classic
 Ford Parts
 PHONE: 770-761-6800**



BULB - (WIPER SWITCH BEZEL)



73-77 Maverick & Comet
 1816...(73 Only...ea).....1.50
 168...(74-77...ea).....1.50

BULB - (GLOVE BOX)



73-77 Maverick & Comet
 1816...(ea).....1.50

BULB - (AM/FM STEREO INDICATOR)



74-77 Maverick & Comet
 1892...(ea).....1.75

BULB - (DOME LAMP)



70-77 Maverick & 71-77 Comet
 105...(70-71...ea).....2.00
 561...(72-77...ea).....2.00

BULB - (MAP LIGHT)



74-77 Maverick & Comet
 105...(ea).....2.00

BULB - (ENGINE COMPARTMENT)



72-77 Maverick & Comet
 631...(72-74...ea).....2.00
 1178...(75...ea).....1.65
 89...(76-77...ea).....1.00

BULB - LED



70-77 Maverick & 71-77 Comet
 37690...(1157 amber).....6.95
 37693...(1157 white).....6.95

HEADLAMP BULB



70-77 Maverick & 71-77 Comet
 01A13007-12V-S...(w/Fomoco script...ea).....25.00
 H6024P...(halogen plain...ea).....16.95
 H6024...(halogen w/Fomoco script...ea).....25.00

HEADLIGHT BULB RETAINING RING



70-77 Maverick & 71-77 Comet
 D3TZ13015A...(ea).....10.50

HEADLAMP ADJUSTING KIT



70-77 Maverick & 71-77 Comet
 AMK3990...(before 8/12/74...28 pc kit).....20.00
 AMK3992...(after 8/12/74...14 pc kit).....20.00

HEADLAMP SPRING



70-74 Maverick & 71-74 Comet
 C6AZ13031C...(70 only...ea).....2.25
 C2OZ13031A...(71-74...ea).....2.50

HEADLIGHT BUCKET BEARING / ANTIRATTLER



75-77 Maverick & Comet
 - 1 kit does both sides
 D5UZ13B160B...(6 per kit).....7.00

**VISIT US ON THE WEB AT:
 WWW.MELVINSCCLASSICFORDPARTS.COM**

HEADLIGHT BUCKET



70-74 Maverick & 71-74 Comet
C9TZ13118A...(RH...ea).....28.00
C9TZ13119A...(LH...ea).....28.00

HEADLIGHT DOOR MOUNTING KIT



70-77 Maverick & 71-77 Comet
MM019...(12 pc kit).....4.00

HEADLIGHT DOOR SCREW



70-77 Maverick & 71-77 Comet
 - (#8 x 1" in Stainless Steel)
9405...(ea)......65

HEADLIGHT SWITCH



70-77 Maverick & 71-77 Comet
D3ZZ11654A...(70-77).....20.00

HEADLIGHT DIMMER SWITCH



70-77 Maverick & 71-77 Comet
SW263.....10.00

DIMMER SWITCH SCREWS



70-77 Maverick & 71-77 Comet
AMK740.....2.25

DIMMER SWITCH GROMMET



70-77 Maverick & 71-77 Comet
MM018.....3.00

HEADLAMP DIMMER SWITCH COVER



70-77 Maverick & 71-77 Comet
C5ZZ13533A.....5.00

DOME LIGHT BEZEL



70-77 Maverick & 71-77 Comet
D0AZ13788A...(Before 6/1/71).....15.00
D1AZ13788A...(After 6/1/71).....20.00

DOME LIGHT LENS



70-77 Maverick & 71-77 Comet
C60Z13783A...(70 to early 71 only).....10.50
D1AZ13783B...(71-77).....8.50
D2LY13783E...(72-77...w/map light).....18.00

MARKER LIGHT LENSES w/FORD SCRIPT



70-77 Maverick & 71-77 Comet
 - Red
D0OZ15A201RD...(ea).....25.00
 - Amber (Mounting studs not included with amber)
D0OZ15A201AM...(ea).....25.00



REAR MARKER LIGHT LENS GASKETS

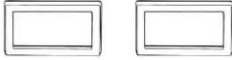

70-77 Maverick & 71-77 Comet
D0ZZ15209...(pr).....2.00

REAR MARKER LIGHT TO BODY GASKET



70-77 Maverick & 71-77 Comet
D1DZ15A447A...(pr).....9.95

TAILLIGHT TO BODY GASKET



70-77 Maverick
D0DZ13420B...(pr).....9.95
71-77 Comet
D0GY13A495D...(pr).....12.95

TAILLIGHT LENS GASKET



70-77 Maverick
D0DZ13461B...(pr).....4.95
71-77 Comet
D0GY13461B...(pr).....10.95

PARKING LIGHT LENS - (CLEAR ONLY)



71-72 Maverick - (Sportlamp)
- These are correct for the 71-72 Maverick Grabber Grille
C9WY13208...(pr).....45.00

PARKING LIGHT LENS GASKETS



70-72 Maverick w/below bumper mounted
D0DZ13211A...(pr).....6.95
71-74 Maverick & Comet w/Grille Mounted Lights
C9WY13211A...(pr).....4.00

REAR MARKER LIGHT - STUD PROTECTORS



70-77 Maverick & 71-77 Comet
PE222...(4 pkg).....3.00

REAR LICENSE LAMP ASSEMBLY



70-73 Maverick & 71-73 Comet
D1ZZ13560.....31.50

REAR LICENSE LAMP LENS



70-76 Maverick & 71-76 Comet
C4AZ13564A.....8.00

REAR LICENSE LAMP LENS GASKET



70-76 Maverick & 71-76 Comet
C7AZ13568A.....1.00



****No Return on Electrical****

Lights

****No Return on Electrical****

PARKING LAMP SOCKET



- 71-74 Maverick & Comet – (Grille Mounted Parking & Sport Lamps)
BAAA13410.....5.00
- 75-77 Maverick & Comet – (Grille Mounted Parking Lamps)
D4OZ13234A.....10.00

TAIL LAMP SOCKET



- 70-77 Maverick
8756.....5.00
- 71-77 Comet - (will NOT replace Reverse/Back-Up Lamp Socket)
- Minor filing/trimming to ears may be required
D4OZ13234A.....10.00

BACK-UP LAMP SOCKET



- 70-77 Maverick
3251...(ea).....5.00

ENGINE/TRUNK COMPARTMENT LIGHT



- 70-72 Maverick & 71-72 Comet
- Dealer Add-on - Can be added to any year
C2RZ15A700A.....25.00



UPS NEXT DAY & 2nd DAY AIR AVAILABLE

TRUNK LIGHT – FACTORY STYLE

- Replacement w/Mercury Activated Switch



- 70-77 Maverick & 71-77 Comet
68-TRUNK-CPE-CV...(72").....45.00

LIGHTING PIGTAILS



- 70-77 Maverick & 71-77 Comet
5225...(headlight pigtail).....3.95
- 8761...(heater control & clock).....5.00
- D0DZ15434.....(marker light).....5.00
- 11437...(dimmer switch).....3.95



Locks

CONSOLETTA LOCK



70-74 Maverick
& all later years or Comet w/added Consolette
C9ZZ6506072A...(non-locking).....20.00
C9ZZ6506072AL...(locking).....25.00



- This kit contains a Consolette lock with matching trunk lock allowing the use of a single key for both.
C9ZZ6506072K.....35.00

TRUNK LOCK



70-77 Maverick & 71-77 Comet
 - Must re-use O.E. Retainer
C7AZ6243505B.....18.95

****NOTE – For Consolette Only - These locks do NOT replace the glove box lock on Mavericks & Comets equipped with a glove box.**

DOOR/TRUNK LOCK GASKET



70-77 Maverick & 71-77 Comet
C7AZ6243625A.....1.50

DOOR LOCK LEVER



70-77 Maverick & 71-77 Comet
 *RH or LH - 1 5/8"
D2AZ6521970A...(ea)..... 5.00

IGNITION CYLINDER



70 Maverick - 6 Cyl w/o locking column
SW814...(w/2 keys...ea).....12.00



70 - 5/15/73 Maverick w/ locking Column
SW1114...(w/2 keys...ea).....28.00
 5/15/73 - 1/76 Maverick & Comet
D3DZ11582...(w/2 keys...ea).....19.95
 2/76-77 Maverick & Comet
D6DZ11582...(w/2 keys...ea).....19.95

IGNITION AND DOORS - SET



70-73 Maverick & 71-73 Comet
D2AZ6522050AR...(w/2 keys).....34.95
 5/15/73 - 1/76
D3DZ622050...(w/2 keys).....35.00

KEY BLANKS



70-77 Maverick & 71-77 Comet
KB5...(ignition/doors).....3.00
KB6...(trunk).....3.00

BUSINESS HOURS
TUES-FRI 8:30-5:00
SATURDAY 8:30-2:00
CLOSED SUNDAY AND
MONDAY
EASTERN STANDARD TIME

Mirrors

INSIDE REARVIEW MIRROR



- 70-77 Maverick & 71-77 Comet
C8AZ17700R...(ea).....32.95
- Chrome, Day/Night with Bracket
S6065X...(universal...ea).....35.00

MIRROR BRACKET



- 70-77 Maverick & 71-77 Comet
C9AZ17698A.....2.50

REARVIEW MIRROR ADHESIVE



- 70-77 Maverick & 71-77 Comet
22014...(ea).....7.50

DOOR MIRROR



- Outside - GT Style (aftermarket)
- S1402...(chrome...ea).....39.95
- S1403...(black...ea).....39.95



SPORT MIRRORS - LENS



- 70-77 Maverick & 71-77 Comet
- Drivers Side
C9AZ17697...(larger than passenger side).....29.95
- Passenger Side
C9AZ17696...(4-3/8" x 2-7/8" ...ea).....19.95

SPORT MIRROR - PASSENGER SIDE BASE TO HEAD MOUNTING PLATE HARDWARE



- 70-77 Maverick & 71-77 Comet
C9AZ17696HDW.....24.95



UPS NEXT DAY & 2nd DAY AIR AVAILABLE

Mirrors

MIRROR MOUNTING KIT - NUTSERTS



70-77 Maverick & 71-77 Comet
 - Used in holes on door to secure mirror, compresses and expands on back side when installed properly. Each package contains two screws and two nutserts, enough for one door/mirror.
AMK802...(4 pc).....3.25

DOOR MIRROR SCREWS



70-77 Maverick & 71-77 Comet
 - Kit does 2 doors/mirrors, S/S - (10-24 X 1")
B12524...(4 pc).....3.25

SPORT MIRROR GASKETS



70-77 Maverick & 71-77 Comet
D0DZ17724PR...(pr).....36.95

WASHER - SPORT MIRROR RETAINING



70-77 Maverick & 71-77 Comet
 - Used on Drivers side
5298.....5.99



SPORT MIRROR REMOTE BEZEL NUT



70-77 Maverick & 71-77 Comet
C9TZ17B732A...(ea).....25.00

REMOTE MIRROR NUT REMOVAL TOOL



- All years w/remote drivers side sport mirror
 - Prevents scratches to chrome nut and painted door
14963...(ea).....18.95

SPORT MIRROR REMOTE WAND



70-77 Maverick & 71-77 Comet
 - Used on Drivers side
D6AZ17B718A.....12.95



***** PRICES ARE SUBJECT TO CHANGE*****
 See disclaimer in front of catalog. Refer to website for current pricing. Confirm prices upon ordering.

Paint & Restoration Supplies

ARGENT SPRAY PAINT



- Great product to aid in the restoration of your grille or Rallye style wheels. 12oz Argent Metallic Aluminum
BD1428...(12 oz).....10.00

ENGINE - SPRAY PAINT



- 12 OUNCE
BD1384...(blue).....10.00
BD1423...(hi temp black).....10.00

DASH PAINT



- Lacquer Black-Metallic Iridescent (Charcoal)
4464...(ea).....12.00

PLASTIC/VINYL DYE



- Black
4464V...(ea).....14.00

PAINT - POWER STEERING PUMP



- Correct blue/green pump color
17520...(ea).....12.95

3M - SUPER TRIM ADHESIVE AEROSOL



08090...(19 oz).....29.95

3M - RUBBERIZED UNDERCOATING



08883...(ea).....12.50

POR 15 EPOXY PUTTY



POR49033.....32.00

POR 15 STARTER KIT



PORSSKB.....22.00

POR PATCH



POR49013.....19.00

POR 15 - SOLVENT



POR40404...(quart).....14.75

Paint & Restoration Supplies

POR 15 - TOP COAT



POR45818...(aerosol).....	24.00
POR45808...(pint).....	31.50
POR45804...(quart).....	46.50

FACTORY MANIFOLD GRAY - Hi Temp Gray Paint



POR44216...(8 oz).....	19.75
POR44208...(pint).....	32.75
POR44218...(aerosol).....	25.00

SELF ETCHING PRIMER



POR41018...(aerosol).....	29.00
POR41008...(pint).....	33.25
POR41004...(quart).....	50.75

TIE COAT - A High Build Primer



POR41108...(pint).....	22.50
POR41104...(quart).....	31.50

BLACK VELVET - Black Hi Temp Paint



POR44116...(8 oz).....	19.75
PORBVP...(pint).....	32.75



ENGINE ENAMEL - Available in many colors



POR42038...(black...pint).....	26.50
POR42048...(corp. blue...pint).....	26.50

POR 20 - Aluminum Hi Temp Paint



POR44316...(8 oz).....	20.75
POR44308...(pint).....	34.25

POR15 - MARINE CLEAN/METAL READY



- Marine Clean removes gum, sludge & varnish from fuel tank. POR40104...(quart).....	11.75
- Metal Ready removes rust from fuel tank and prepares it for sealing. POR40204...(quart).....	18.00

FUEL TANK SEALER - POR15



POR49216...(8 oz).....	13.00
POR49208...(pint).....	24.95
POR49204...(quart).....	42.95

PAINT - POR 15



POR45408...(semi-gloss black...pint).....	31.50
POR45404...(semi-gloss black...quart).....	47.50
POR45008...(gloss black...pint).....	31.50
POR45004...(gloss black...quart).....	47.50

Paint & Restoration Supplies

POR 15 BOSS GLOSS



Cleans and protects plastic, rubber, vinyl
 POR-BGH...(8 oz.).....11.00
 POR-BG20...(20 oz.).....23.00

BRAZILIAN CARNAUBA WAX



12 oz. can
 POR-CW.....17.95

POR 15 DAUBER KIT



Thin wire with wool tips on both ends, can easily be bent to fit your needs.
 Kit contains 2 each of 3 different double ended sizes.
 POR-DBK.....22.00

LITHIUM GREASE - Multi-Purpose



- Brand may change from one in photo
 Also used in steering sector, takes one full cartridge of lithium grease if rebuilding steering sector.
 LITHIUMGR...(14oz cartridge).....7.00

WHEEL BEARING GREASE



Timken Brand, 1 lb.
 GREASE.....8.00



**Melvin's Classic
 Ford Parts
 PHONE: 770-761-6800**

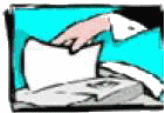

SPEEDOMETER CABLE LUBE



- Prevents, Eliminates wear & noise
 - Place on cable prior to inserting cable into sleeve
 B5A19581A.....3.00

DISTRIBUTOR CAM LUBE



7/8 oz.
 SL-2.....6.95

FORMULA 5 PRE-LUBE



- 1/2 oz. Bushing Lube. Use on all Poly suspension parts when installing new parts to prevent metal-to-metal contact even under severe shock loads. Also prevents corrosion and squeaking.
 9-11108...(ea).....1.00

PAINT MARKER SET



MARK12...(12 pc).....22.50

BODY SEAM SEALER



B11608...(dk gray).....22.95

***** PRICES ARE SUBJECT TO CHANGE*****
 See disclaimer in front of catalog. Refer to website for current pricing. Confirm prices upon ordering.

Paint & Restoration Supplies

PERMATEX GASKET SEALER



3 oz. tube
80016.....5.00

RTV HI-TEMP SILICONE



598BR...(ea).....6.95

3M WEATHERSTRIP ADHESIVE



- Black in color, 5oz tube
08008.....15.00

HEADLINER GLUE



HLG1829...(4 oz brush on...ea).....9.95



ADHESIVE REMOVER/CLEANER



08984...(ea).....19.95

REARVIEW MIRROR ADHESIVE



70-77 Maverick & 71-77 Comet
22014...(ea).....7.50

WINDSHIELD & BODY SEALANT



- Non-curing Butyl sealant, remains tacky.
 Black, 11 oz cartridge.
CRL7708...(11 oz).....12.95

SEAM SEALER



29382...(tan...ea).....15.95



Radiator

RADIATORS



2 Row Core
70-73 Maverick & 71-73 Comet
329RADIATOR...(170/200).....269.95

74-77 Maverick & Comet
423RADIATOR...(250).....350.00

3 Row Core
70-73 302 wo/AC & 71-73 250 with or wo/ AC
339RADIATOR.....350.00

RADIATOR CAP



70-77 Maverick & 71-77 Comet
- 13 lbs. pressure
RS62CHROME.....20.00
RS62ZINK.....20.00

TRANSMISSION OIL COOLER LINE FITTINGS



70-77 Maverick & 71-77 Comet
359279S...(pr).....6.50

RADIATOR DRAIN VALVE



70-77 Maverick & 71-77 Comet
8A8115.....5.00

FAN SHROUD HARDWARE



73-77 Maverick & Comet
AMK403...(6 cyl or V8).....6.75

VISIT US ON THE WEB AT:
WWW.MELVINSCLASSICFORDPARTS.COM

RADIATOR COOLING FAN



70 Maverick
- 4 Blade-6 cyl
C2DZ8600D.....64.95

FAN SPACER



- 2¼" spacer mounts between pulley on water pump and fan
C4AZ8546A.....21.95
C4AZ8546P...(polished).....26.95
C3OZ8546A...(w/logo).....49.95
C4AZ8546A1...(1 ½").....20.00

THERMOSTAT HOUSING



70-77 Maverick & 71-77 Comet
C1DZ8592D...(6 cyl).....18.95
C5OE8592A...(302...w/recess).....19.95
C5ZZ8592C...(302...chrome).....18.00
35067...(gasket...302).....2.00

THERMOSTAT / WATER NECK HARDWARE



70-77 Maverick & 71-77 Comet
AMK504...(170/200).....3.68
AMK505...(250).....3.68
AMK506...(302).....3.68

THERMOSTAT



70-77 Maverick & 71-77 Comet
6 cyl or V8
RT350...(160°).....8.95
RT351...(180°).....7.95
RT1139...(190°).....7.95

Radiator

BY-PASS HOSE



70-72 Maverick & 71-72 Comet
- Autolite Script

BP2.....7.00

72-77 Maverick & 72-77 Comet
- Motorcraft Script

BP3.....7.50

HEATER HOSE CLAMP



70-77 Maverick & 71-77 Comet

AMK383...(6 pc).....12.00

RADIATOR HOSE CLAMP



70-77 Maverick & 71-77 Comet

B13106...(1 3/4" ...2 pc).....8.50

B13107...(2" ...2 pc).....8.50

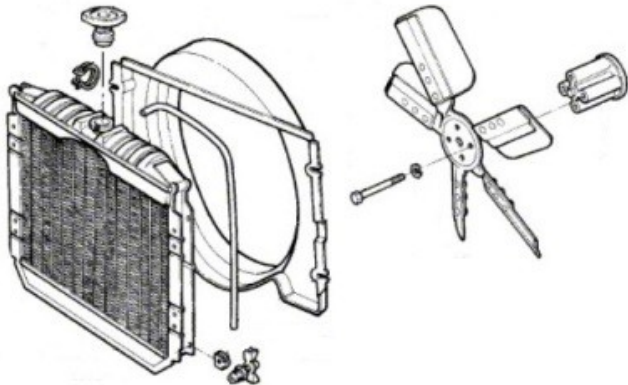

BUSINESS HOURS
TUES-FRI 8:30-5:00
SATURDAY 8:30-2:00
CLOSED SUNDAY AND
MONDAY
EASTERN STANDARD TIME

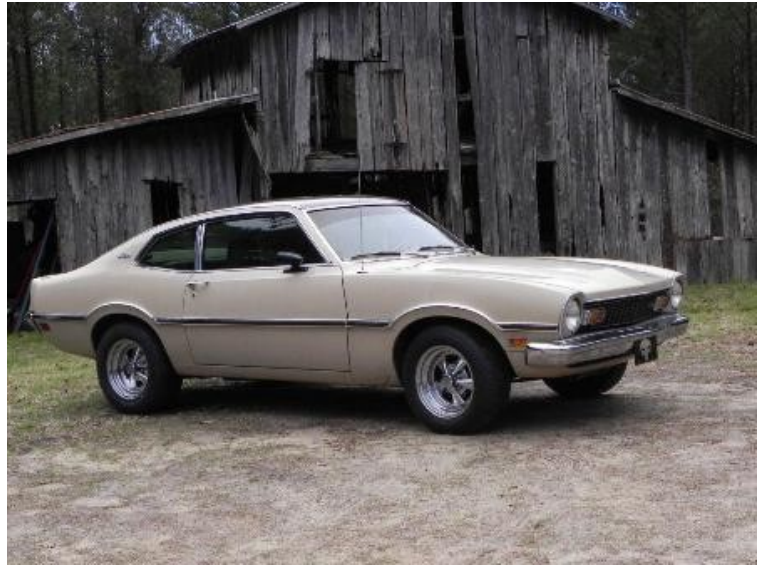

Radio Related

ANTENNA



- 70-77 Maverick & 71-77 Comet
 - Telescoping Replacement w/rectangle base
D0DZ18813A...(70-72 exact repro).....90.00
D1ZZ18813.....75.00
D3AZ18813R.....18.95

ANTENNA CABLE CLIP



- Used to secure antenna cable under dash
376118S...(ea).....1.95

ANTENNA CABLE GROMMET



- 70-77 Maverick & 71-77 Comet
 - Seals where cable passes through the A pillar
C7OZ18912S.....5.95

UNDERCOVER SPEAKER ENCLOSURES



- Aftermarket, stealth, can be hidden under seat, 120 watt capacity 5 1/2" woofer and a Piezo twitter in ea. 3"x 8 1/4" x 11 1/4".
UNDERCOVER1...(pr).....120.00

RADIO KNOBS



- 73-74 Maverick & Comet
D1ZZ18817...(4 pc).....50.00
 75-77 Maverick & Comet
D3AZ18817A...(ea).....6.00

SPEAKER GRILLE



- 70-77 Maverick & 71-77 Comet
 - Exact Reproduction of Rear Package Tray Speaker Grille
C5ZZ18798A...(ea).....45.00



**Melvin's Classic
 Ford Parts
 PHONE: 770-761-6800**



Radio Related

IN DASH 5" x 7" SPEAKER



70-77 Maverick & 71-77 Comet
 -Minor Modification may be necessary
SPEAKER3.....20.00

Aftermarket 30 Watt, 3" Dual Cone in Dash Speaker
 -Minor Modification may be necessary
SPEAKER4.....35.00

Mounting Hardware
AMK2025...(4 pcs).....2.68

PACKAGE TRAY REAR SPEAKERS



- Aftermarket
 200 Watt, 6 x 9, w/grilles
C5AZ18808...(w/hardware...pr).....79.95

SPEAKER SYSTEM



150 watt subwoofer / 2x50 watt mid-tweeter
 Solves the problem of where to put speakers in older cars,
 satellite speakers look similar to ac vents!
SYSTEM1...(kit).....299.00

RADIO SUPRESSOR



1972 Maverick & Comet
C6OZ18832AL.....31.95

CD PLAYER - (Single CD)



CAM-CD1.....169.00

RADIO



70-72 Maverick & Comet (Allow 2-3 weeks for delivery)
KHE100.....259.00



UPS NEXT DAY & 2nd DAY AIR AVAILABLE

Rubber Bumpers / Plugs / Grommets

ASH TRAY BUMPER

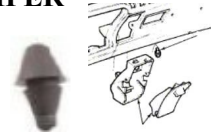

70-77 Maverick & 71-77 Comet
358159A2S.....3.00

GLOVE BOX BUMPERS



73-77 Maverick & Comet
PE120... (pr).....1.50

CONSOLETTA DOOR RUBBER BUMPERS



All Mavericks and Comets with a factory consolette
 - Used to cushion door upon closing.
 - Not factory correct but work very nicely
PE251... (pr).....2.00

CLUTCH PEDAL BUMPER



70-77 Maverick & 71-77 Comet
C8OZ7583A.....10.00

DOOR BUMPERS



70-77 Maverick & 71-77 Comet
PE199... (2 req...pr).....3.00
PE129... (4 req...4 pkg).....3.75

WINDOW STOP BUMPER



70-77 Maverick & 71-77 Comet
C6OZ7621762S... (ea).....1.50

HOOD BUMPERS



70-77 Maverick & 71-77 Comet
380478S2... (firewall to hood...pr).....5.00
C7AZ16758A... (fender to hood...4 pc).....8.95

FRONT SUSPENSION BUMPER



70-77 Mavericks & 71-77 Comet
C9OZ3020... (ea).....10.00

REAR AXLE BUMPER



70-74 Maverick & 71-73 Comet
C6AZ4730A... (ea).....8.00



Rubber Bumpers / Plugs / Grommets

REAR VALANCE TAG BUMPERS



70-73 Maverick & 71-73 Comet
375838S...(pr).....4.00

TRUNK/DECK LID BUMPERS



70-77 Maverick & 71-77 Comet - (2 door models)
PE184...(pr).....3.50

RADIATOR SUPPORT BUMPERS



70-77 Maverick & 71-77 Comet
PE380...(pr).....5.00
C5ZZ16763S...(stainless...pr).....25.00

RUBBER BUMPERS - KIT



70-77 Maverick & 71-77 Comet
 - Kit includes bumpers for: ashtray, doors, hood, hood to firewall, rear tag, trunk & radiator support. Over \$5 in savings!!
MM880.....30.00

RUBBER PLUGS



70-77 Maverick & 71-77 Comet
377949S...(7/8" ...ea).....1.25
377678S...(1" ...ea).....1.50
377936S...(1 1/4" ...ea).....1.75
383796S...(2 1/4" ...ea).....2.75

BRAKE ADJUSTMENT HOLE PLUGS



70-77 Maverick & 71-77 Comet
PE108...(4 pc).....3.00

QUARTER PANEL DRAIN PLUGS



70-71 Maverick & 71 Comet
PE601...(pr).....8.00

ANTENNA CABLE GROMMET



70-77 Maverick & 71-77 Comet
 - Seals where cable passes through the A pillar
C7OZ18912S.....5.95

AC LINE GROMMETS AT RADIATOR SUPPORT



71-72 Maverick & Comet
 *6 cyl. Hang-on AC only
378264S...(pr).....9.95

AC DRAIN & HEATER HOSE GROMMETS



70-77 Maverick & 71-77 Comet
382745...(pr).....15.00

CONDENSER TUBE A/C LINE GROMMET



70-77 Maverick & 71-77 Comet w/Integral A/C
 - Protects A/C Lines as they pass through radiator support -
 - Must Glue to Bracket -
C7ZZ19819.....3.00

CLUTCH PIVOT DUST GROMMET

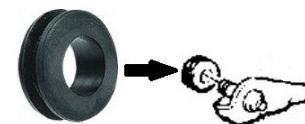

71-76 Maverick & Comet w/302
4428...(V8)......95

Rubber Bumpers / Plugs / Grommets

DIMMER SWITCH GROMMET



70-77 Maverick & 71-77 Comet
MM018.....3.00

BRAKE LINE SHOCK TOWER GROMMET



70-77 Maverick & 71-77 Comet
 - Used on shock tower where brake line passes through to engine compartment
B14604...(ea).....5.00

FUEL VAPOR VALVE GROMMET



F6TZ9B076AA.....7.95

FUEL LINE APRON GROMMET



71-77 Maverick & 71-77 Comet
D1ZZ9288...(ea).....2.00

GRILLE TO STONE GUARD GROMMETS



70-77 Maverick & 71-77 Comet
FA4561...(pr).....2.50



SPEEDOMETER CABLE GROMMET



70-77 Maverick & 71-77 Comet
380634S...(ea).....2.50

VALVE COVER PCV GROMMET



70-77 Maverick & 71-77 Comet
 8 Cylinder (302)
C6AZ6892...("D" shaped).....4.00
C8SZ6892...(6 or 8 cyl, use w/elbow).....2.00

CAR COVER ANTENNA GROMMET



- Installs on Car Cover to allow use of stock antenna -
 - Snaps together to prevent car cover from tearing -
CC-AG.....3.00



Sheet Metal

QUARTER PANEL - (**Upsize S/H**)

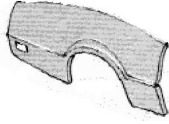

70-77 Maverick & 71-77 Comet
RFP98-RH...(for 2 dr...must alter for 4 dr).....250.00
RFP98-LH...(for 2 dr...must alter for 4 dr).....250.00
 (shipping estimate is \$150 each or pair)

SHEET METAL ALTERNATIVES

- Below are sheet metal cowl repair options for your Maverick or Comet project. These are correct for Mustangs but have been successfully installed in Mavericks & Comets due to none currently reproduced for the Maverick/Comet community. As with any sheet metal part not made specific to your vehicle, some modification **WILL BE** required.
****ONCE ORDERED, NO RETURNS!!**

INNER COWL VENT REPAIR PANELS

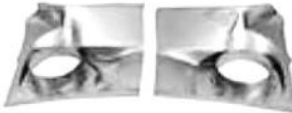

Alternative for Maverick & Comet (see description above)
M136RH.....60.00
M136LH.....60.00

BATTERY TRAY REINFORCEMENT PLATE

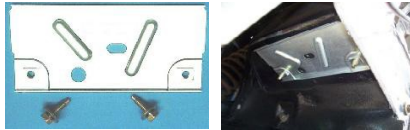

70-77 Maverick & 71-77 Comet
 - Correct for 68 Mustangs & Cougars, but works very well
C8ZZ16060AR.....36.95

FENDER - (**Upsize S/H**)



70-72 Maverick & 71-72 Comet
5030...(RH w/marker light hole).....399.00
5032...(RH wo/marker light hole).....399.00
5031...(LH w/marker light hole).....399.00
5033...(LH wo/marker light hole).....399.00

SHEET METAL ALTERNATIVES

- Below are sheet metal floor pan options for your Maverick or Comet project. These are correct for Mustangs but have been successfully installed in Mavericks & Comets due to none currently reproduced for the Maverick/Comet community. As with any sheet metal part not made specific to your vehicle, some modification **WILL BE** required.
****ONCE ORDERED, NO RETURNS!!**

FRONT FLOOR PAN



Alternative for Maverick & Comet (see description above)
M106LH...(front left).....33.00
M106RH...(front right).....33.00

REAR FLOOR PAN



Alternative for Maverick & Comet (see description above)
M108LH...(rear left).....39.00
M108RH...(rear right).....39.00

FLOOR PAN METAL PLUG



Maverick & Comet
C8ZZ6511117...(ea).....6.00

SPARE TIRE BOLT BRACKET



- Must be spot welded to trunk floor
C7AZ6547076.....7.95

UNIVERSAL LOWER DOOR SKIN

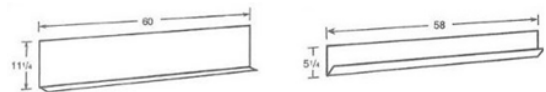

70-77 Maverick & 71-77 Comet
960-12...(11 1/4" x 60" w/ "L" lip).....25.00
960-14...(5 1/4" x 58" w/"J" lip).....35.00

Sheet Metal

SHEET METAL ALTERNATIVES

- Below are sheet metal lower wheelhouse patch panel options for your Maverick or Comet project. These are correct for 65-66 Mustangs but have been successfully installed in Mavericks & Comets due to none currently reproduced for the Maverick/Comet community. As with any sheet metal part not made specific to your vehicle, some modification **WILL BE** required.

****ONCE ORDERED, NO RETURNS!!**

LOWER WHEELHOUSE PATCH PANELS



Alternative for Maverick & Comet (see description above)

M113A...(RH).....30.00
M113A...(LH).....30.00

FRONT FENDER APRON - RH INNER

- Below is a inner fender apron option for your Maverick or Comet project. These are correct for 67-68 Mustangs but a section from this panel has been successfully installed on Mavericks & Comets due to none currently reproduced for the Maverick/Comet community. As with any sheet metal part not made specific to your vehicle, some modification **WILL BE** required. This apron can be used to repair the area under the battery tray.

****ONCE ORDERED, NO RETURNS!!**



3634J.....45.00

REAR VALANCE - OPTION - (Oversize S/H)

-Below are sheet metal rear valance options for your Maverick or Comet project. These are correct for 69-70 Mustangs but have been successfully installed on Mavericks & Comets due to none currently reproduced for the Maverick/Comet community. As with any sheet metal part not made specific to your vehicle, some modification **WILL BE** required. The area under the bumper protrudes outward more than the OEM panel. Will require work where Valance meets Quarter Panels.

****ONCE ORDERED, NO RETURNS!!**



70-73 Maverick & 71-73 Comet
3643K...(w/o exhaust cuts).....85.00
3643L...(w/ exhaust cuts).....85.00

INNER TRUNK BRACKET/BRACE



70-73 Maverick & 71-73 Comet
- Replacement for 70-73 and a must if converting to small rear bumper on 74-77 Maverick and Comet – fits LH & RH
MM634LR...(ea).....15.00

STONE GUARD - FRONT - (Oversize S/H)



70-72 Maverick
5010.....129.95

FRONT VALANCE - (Oversize S/H)



70-72 Maverick & 71-72 Comet
5011.....225.00

HOOD, "GRABBER" - (Oversize S/H)

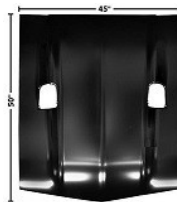

Box Size:
54.5" x 50.5" x 6.5"
Weight:
54 lbs.



Underside View

71-72 Maverick "Grabber" - (will fit all years)
** (for Grabber Scoops, see pg. 55)
5002.....525.00

RADIATOR SUPPORT - (Oversize S/H) - COMING SOON



70-77 Maverick & 71-77 Comet
5020.....CALL

VISIT US ON THE WEB AT:
WWW.MELVINSCCLASSICFORDPARTS.COM

Steering

STEERING SECTOR WORM SHAFT BEARING



Bearings come with Race
70-77 Maverick & 71-77 Comet
C2AZ3571SET...(2 req...ea).....40.00

STEERING SECTOR BUSHING/BEARING



70-77 Maverick & 71-77 Comet
C1AZ3576B...(2 req...ea).....12.75

STEERING SECTOR COVER GASKET



70-77 Maverick & 71-77 Comet
C3AZ3581A.....3.00

STEERING SECTOR SHAFT OIL SEAL



70-77 Maverick & 71-77 Comet
8A3591A.....5.50

STEERING COLUMN TUBE BEARING & SLEEVE



70-77 Maverick & 71-77 Comet
- This fits the upper portion of the column
F23Z3517B...(bearing).....20.00
E2AZ3518C...(sleeve).....7.00

**VISIT US ON THE WEB AT:
WWW.MELVINSCLASSICFORDPARTS.COM**

PITTMAN ARM TO STEERING SECTOR NUT



70-77 Maverick & 71-77 Comet
B12805.....2.95

PITTMAN ARM



75-77 Maverick & Comet
- With Manual Steering
RP20130.....98.00

IDLER ARM



70-72 Maverick & 71-72 Comet
RP20395.....75.00



73-74 Maverick & Comet
RP20251.....95.00



75-77 Maverick & Comet
RP20261.....80.00

IDLER ARM BUSHING



70-77 Maverick & 71-77 Comet
- Mounts in the end of the center link, however not all applications mounted this way, confirm before ordering
RP15319...(70-77).....15.00
17286...(75-77 - bracket end).....30.00

Steering

POWER STEERING CONTROL VALVE



70-76 Maverick & 71-76 Comet (all before 4/5/76)
New, not rebuilt
FR1498-VLV.....550.00

POWER STEERING CONTROL VALVE END CAP



70-76 Maverick & 71-76 Comet (all before 5/1/76)
C2AZ3C705A.....25.00

CONTROL VALVE SEAL AND BALL STUD REBUILD KIT, INCLUDES STUD SOCKET



70-76 Maverick & 71-76 Comet (Before 6/1/76)
C3AZ3A650B...(20 pc kit).....55.00

CONTROL VALVE BALL STUD SOCKET - BRASS



70-77 Maverick & 71-77 Comet
C1AA3A754C.....19.95

SLAVE CYLINDER DUST BOOT & CLAMP



70-77 Maverick & 71-77 Comet
C5ZZ3A540B.....14.50

SLAVE CYLINDER BRACKET TO FRAME CRUSH NUT



70-77 Maverick & 71-77 Comet
- Inserts into frame and crushes upon tightening bolt to secure bracket to frame, 2 Required
375474S8...(ea).....3.50

POWER STEERING BRACKET SPACER



71-77 Maverick & Comet
B13195...(ea).....6.50

POWER STEERING CYLINDER SEAL KIT



70-77 Maverick & 71-77 Comet
C1AZ3A764A...(kit).....16.00

POWER STEERING PUMP SEAL/GASKET KIT

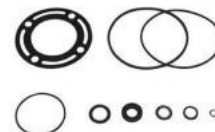

70-77 Maverick & 71-77 Comet
- All with Ford Pump-
D1AZ3B584A...(kit).....21.95

POWER STEERING PUMP CAP



71-72 Comet
C7AZ3A006B...(zinc...ea).....18.00

POWER STEERING HOSE INSULATOR



70-77 Maverick & 71-77 Comet
C7ZZ3A609A...(ea).....7.50

SLAVE CYLINDER BOOT INSULATOR KIT



70-77 Maverick & 71-77 Comet
C3AZ3C651A.....13.00

Steering

HOSE - POWER STEERING - PRESSURE



6 CYL - 5/16" Male Inverted Flare x 3/8" Female S.A.E 70-76 Maverick & 71-76 Comet w/170 & 200 80157	28.00
70-74 Maverick & 71-74 Comet w/250 70652	30.00
75-76 Maverick & Comet w/250 (Before April 4, 1976) 80155	29.95
6 CYL - 5/16" Male O-ring x 3/8" Male O-ring 76-77 Maverick & Comet w/250 (After April 4, 1976) 80027	28.00
V8 (302) Control Valve End 5/16" Male Inverted Flare x 3/8" Female S.A.E 71-76 Maverick & Comet (Before April 4, 1976) 70679	29.00
5/16" Male O-ring x 3/8" Female S.A.E 76-77 Maverick & Comet (After April 4, 1976) 80029	25.00
V8 (302) Pump End 3/8" Male Inverted Flare x 3/8" Male S.A.E 71-74 Maverick & Comet 70678	11.50
75-76 Maverick & Comet - (Before April 4, 1976) 70682	29.95
V8 (302) Pump End 3/8" Male S.A.E x 3/8" Male O-ring 76-77 Maverick & Comet - (After April 4, 1976) 70710	29.95

HOSE - CONTROL VALVE TO POWER CYLINDER



70-76 Maverick & 71-76 Comet - (Before April 4, 1976) - From Control Valve to Cylinder - Front C6OZ3A714/17A...(pr)	44.95
76-77 Maverick & Comet - (After April 4, 1976) 5/16" Male O-ring x 5/16" Male O-ring 80028...(2 Req)	CALL

HOSE - POWER STEERING - RETURN



70-72 Maverick & 71-72 Comet 3/8" Male Inverted Flare x 3/8" I.D Hose 80113	21.95
73-75 Maverick & Comet 3/8" Male Inverted Flare x 3/8" I.D Hose 70656	18.00
76 Maverick & Comet 3/8" Male Inverted Flare x 3/8" I.D Hose 80113	21.95
3/8" Male O-ring x 3/8" I.D Hose 80030	19.95
3/8" Male O-ring x 3/8" Beaded Tube 70737...(w/V8-302)	18.00
77 Maverick & Comet 3/8" Male O-ring x 3/8" I.D Hose 80030	19.95
3/8" Male O-ring x 3/8" Beaded Tube 70737...(w/V8-302)	18.00

POWER STEERING HOSE - PROTECTOR SLEEVE



70-77 Maverick & 71-77 Comet C9ZZ3713P	22.95
--	--------------

MANUAL STEERING ADAPTER



70-77 Maverick & 71-75 Comet - Now an inexpensive and easy way to convert power steering cars to manual steering. This will give you a more precise feel for the road or track. Eliminates leaking systems and costly repairs. Installs in minutes with no special tools. 27483...(ea)	169.95
---	---------------



Steering

INNER TIE ROD



70-74 Maverick & 71-74 Comet
ES487R...(LH or RH).....35.00
 75-77 Maverick & Comet
25560...(LH or RH).....80.00

OUTER TIE ROD



70-74 Maverick & 71-74 Comet
ES387R...(LH or RH).....20.00
 75-77 Maverick & Comet
ES445R...(LH or RH).....28.00

TIE ROD END DUST SEAL



70-74 Maverick & 71-74 Comet
DOOZ3332...(ea).....6.00

TIE ROD SLEEVES



70-72 Maverick & 71-72 Comet
ES2004S...(L.H. or R.H...before 8/8/72).....10.00
 72-77 Maverick & Comet
ES426S...(L.H. or R.H...after 8/8/72).....22.95

CENTER LINK



70-74 Maverick & 71-74 Comet
 - With Manual Steering
RP25821.....195.00
Core Fee.....45.00



75-77 Maverick & Comet
 - With Manual Steering
RP25881.....149.95



75-77 Maverick & Comet
 - With Power Steering
RP25914.....130.00

STEERING GEARBOX WASHER



70-77 Maverick & 71-77 Comet
B13024...(3 pc).....4.25

REMANUFACTURED POWER CYLINDER



70-74 Maverick & 71-74 Comet
 - A core charge applies to this item, allow 2-3 weeks turnaround
DOOZ3A540A...ea.....175.00

***** PRICES ARE SUBJECT TO CHANGE*****
 See disclaimer in front of catalog. Refer to website for
 current pricing. Confirm prices upon ordering.

BUSINESS HOURS
TUES-FRI 8:30-5:00
SATURDAY 8:30-2:00
CLOSED SUNDAY AND
MONDAY
EASTERN STANDARD TIME

GRABBER SIDE STRIPE DECALS

70 Maverick Grabber
One Color Non Reflective, Grabber name not in Stripe



- M100-BK...(black gloss).....155.00
- M100WH...(white).....155.00



- 71 Maverick Grabber
Non Reflective
- M200-BK...(black gloss).....145.00
 - M200-WH...(white).....145.00
- *Reflective*
- M200-BKOR...(black/orange).....275.00
 - M200-BKYE...(black/yellow).....275.00
 - M200-WHWH...(white).....275.00

GRABBER HOOD STENCIL



- M210-H-ST.....49.00

72 MAVERICK GRABBER



- Grabber name in Stripe
- M300-BK...(black gloss...ea).....145.00
 - M300-WH...(white...ea).....145.00

BUSINESS HOURS
TUES-FRI 8:30-5:00
SATURDAY 8:30-2:00
CLOSED SUNDAY AND
MONDAY
EASTERN STANDARD TIME

TWIN SCOOP HOOD DECAL

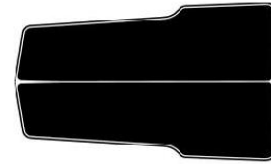

- M310-H-BK...(black gloss).....85.00
- M210-H-MBK-XX...(custom black matte).....115.00

1973 MAVERICK GRABBER SIDE STRIPES AND TRUNK STRIPE



- The lower stripe is applied over the painted edge.
- M401-BK...(black gloss).....175.00
 - M401-BL...(blue).....175.00
 - M401-AWH...(antique white).....175.00

Picture shows actual stripes used on 1973 Grabber.
Bottom of car painted then stripe kit applies over paint for finish look.
Grabber name is paint stencil which is removed after painting allowing paint color to show through.

1973 MAVERICK GRABBER FENDER NAME PAINT STENCIL



- M420-ST...(ea).....30.00

1973-75 MAVERICK GRABBER HOOD DECAL



- Hood decal has 'GRABBER' name cut out. Matches side stripe color.
- M400-HD...(black gloss).....105.00
 - M401-HD-BL...(blue).....105.00
 - M401-HD-AWH...(antique white).....105.00
 - M405-HD-BG...(black gloss - no name).....115.00
 - M405-HD-BM...(black matte - no name).....115.00
 - M405-HD-WH...(white - no name).....115.00



1974-75 MAVERICK GRABBER SIDE STRIPES



One color non-reflective stripe, 'GRABBER' name in stripe.
No trunk stripe available. Rear Grabber stencil available

- M500-HD...(black gloss).....195.00
- M500-HD-BL...(blue).....195.00
- M500-HD-AWH...(antique white).....195.00

1974-75 MAVERICK GRABBER TAIL PAINT STENCIL



Stencil allows paint color to show through Grabber name in black painted area between tail lights. One required. Not all cars had this option.

- M520-ST.....27.00

MAVERICK LOGO, LOWER SIDE STRIPE KIT



86" long. Install between wheel wells with logo on fender and Maverick name on door.

- M575-BK...(black gloss).....75.00
- M575-WH...(white).....75.00
- M575-GO...(gold metallic).....75.00
- M575-SL...(silver).....75.00

1972 MAVERICK SPRINT DUAL HOOD STRIPES



*Note – Cowl Section is Painted

- MM335-OBRD...(blue with red pin stripe like factory).....135.00

1972 MAVERICK SPRINT ¼ INCH WIDE TAPE



*Does lower pinstripe above lower painted section

- M336-RD...(red).....24.00

1972 SPRINT U.S.A. BODY SHIELD DECAL SET



- M340...(Maverick Sprint Shield)...set.....28.00

1976 - MAVERICK STALLION FENDER DECAL



- DF1209...(rt fender - red/orange)...ea.....13.50
- DF1210...(lt fender - red/orange)...ea.....13.50



- DF815...(rt fender - orange/red)...ea.....13.50
- DF816...(lt fender - orange/red)...ea.....13.50

COMET "GT" STRIPE KITS



1971-72 COMET GT SIDE STRIPES

*Kit Does Both Sides

"COMET GT" appears on Fenders

- A700-BK...(black).....95.00
- A700-WH...(white).....95.00
- A700-SL...(silver metallic).....95.00

1973-74 COMET GT SIDE STRIPES

*Kit Does Both Sides

"COMET GT" appears on Rear Quarters



- A710-BK...(black).....125.00
- A710-WH...(white).....125.00
- A710-SL...(silver metallic).....125.00

****HOOD DECALS OR STENCILS NOT AVAILABLE FOR COMET**

Suspension

FRONT COIL SPRINGS



70-77 Maverick & 71-77 Comet
-6 cyl
 1970 - (170) 2 door
CS8088...(w/AC...pr).....99.95
 71-72 (170 & 200) 2 door Grabber model
CS8088...(w/o AC...pr).....99.95
 71-72 (250) 2 door
CS8088...(w/o AC...pr).....99.95
 73 - (250) 4 door
CS8304...(w/AC...pr).....99.95
 75-76 (250) 2 & 4 door
CS8304...(w/AC...pr).....99.95

8 cyl
 71-72 4 door
 71-72 Grabber & GT Package
 73 2 door w/AC
 73 4 door w/o AC
 74 2 & 4 door w/ & w/o AC
 75-76 2 & 4 door w/o AC
 77 w/AC & Heavy Duty Package
CS8304...(pr).....99.95
 73-74 '73 W/302 & 73-74 W/200-250
CS8318...(pr).....99.95

***NOTE - COIL SPRINGS TAKE SEVERAL MONTHS TO SETTLE**

FRONT COIL SPRING INSULATOR



70-77 Maverick & 71-77 Comet
C4DZ5415A...(ea).....4.00
C4DZ5415POLY...(pr).....21.95

UPPER CONTROL ARM SPRING SEAT w/BUSHING



70-77 Maverick & 71-77 Comet
 Stock Replacement
D7DY3388AR...(ea).....30.00
 Greasable 360 degree Rotating Shaft
C4DZ3388HP...(ea).....59.95

SPRING SEAT BUSHING



70-77 Maverick & 71-77 Comet
C7OZ5A305R...(ea).....19.95

UPPER CONTROL ARMS



70-77 Maverick & 71-77 Comet
 70 before 7/14/69
C4DA3082R...(w/4 hole...ea).....110.00
 70-77 Maverick & 71-77 Comet
D5DZ3082R...(w/3 hole...ea).....110.00

FRONT SUSPENSION BUMPERS



70-77 Mavericks & 71-77 Comet
C9OZ3020...(ea).....10.00

UPPER CONTROL ARM BALL JOINT



70-77 Maverick & 71-77 Comet
10230...(4 bolt...before 7/14/69...ea).....22.00
10235...3 bolt...after 7/14/69...ea).....22.00

BALL JOINT DUST SEAL - UPPER



70 Maverick - (Used on 4 Bolt Ball Joint ONLY)
C7OZ3A105B...(ea).....8.00



**Melvin's Classic
 Ford Parts
 PHONE: 770-761-6800**



Suspension

UPPER CONTROL ARM SHAFT KIT



70-77 Maverick & 71-77 Comet
13173A... (ea).....35.00

UPPER CONTROL ARM GREASE FITTING KIT



- Special zerk fittings with extra long extensions. Helps solve squeaky upper control arms. Installation tool included.
 70-77 Maverick & 71-77 Comet
374714SK... (ea).....16.95

UPPER CONTROL ARM SHAFT BOLT



70-72 Maverick & 71-72 Comet
B10125... (pr).....8.25

UPPER CONTROL ARM NUTS



- Secures upper control arm shaft bolt to vehicle
 70-77 Maverick & 71-77 Comet
B12798... (4 pc).....3.50

LOWER CONTROL ARMS



70-77 Mavericks & 71-77 Comet
10812... (ea).....53.50

LOWER CONTROL ARM BUSHING



70-77 Maverick & 71-77 Comet
12268... (1-7/16" O.D...pr).....16.25

BALL JOINT DUST SEAL - LOWER



70-77 Maverick & 71-77 Comet
C7OZ3A105A.....8.00

CAM BOLT & NUT KIT



70-77 Maverick & 71-77 Comet (kit does 1 vehicle)
AMK1515... (kit).....25.00

STRUT ROD



71-73 Maverick & Comet
18061... (LH).....69.95
18071... (RH).....69.95

STRUT ROD BUSHINGS



70-77 Maverick & 71-77 Comet
C6OZ3A187A... (4 pc).....28.95

STRUT ROD TO BODY HARDWARE



70-77 Maverick & 71-77 Comet
AMK659... (4 pc).....11.25

SWAY BAR BUSHING



70-77 Maverick & 71-77 Comet
C4DZ25493B... (5/8").....8.99
9-5104... (5/8" poly).....21.00
C6OZ5493B... (3/4").....6.95
9-5108G... (7/8" poly).....21.00

Suspension

SWAY BAR END LINK KIT



70-76 Maverick & 71-76 Comet (all before 2/2/76)
AMK3950...(rubber bushing).....25.00
9-8117G...(polyurethane bushing).....21.50

SHOCK TOWER CAP NUT AND BOLT SET



70-77 Maverick & 71-77 Comet
AMK313...(6 pc).....11.25

FRONT LOWER SUSPENSION CROSSMEMBER



71-77 Maverick & Comet
 - Can be used as a replacement or V8 upgrade
D0DZ5025A...ea.....CALL

FRONT CROSSMEMBER BOLTS



70-77 Maverick & 71-77 Comet w/V8
AMK1280...(pr).....11.25

FRONT HUB GREASE CAP



70-77 Maverick & 71-77 Comet
B5A1131A...(ea).....4.50

TRACTION BARS



70-77 Maverick & 71-77 Comet
TM1074...(pr).....249.95

REAR LEAF SPRINGS - (**Over**size S/H)



70-77 Maverick & 71-77 Comet
 - A replacement Heavy Duty (4) Leaf spring – Sold as a Pair
42-717...(pr).....199.95

REAR LEAF SPRING CENTERING BOLT



70-77 Maverick & 71-77 Comet
B10222...(pr).....8.25

REAR SPRING CLAMP KIT



70-77 Maverick & 71-77 Comet
C4DZ5724B...(kit).....28.00

REAR SPRING ANTI-SQUEAK PAD

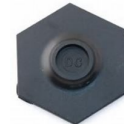

70-75 Maverick & 71-75 Comet (all before 5/1/75)
C0AA5586B...(ea).....1.25

REAR LEAF SPRING - FRONT BUSHING



70-77 Maverick & 71-77 Comet
C4DZ5630C...(ea).....30.00

REAR SPRING BUSHING BOLT



70-77 Maverick & 71-77 Comet
35185...(ea).....15.95

Suspension

REAR SPRING U-BOLT



70-74 Maverick & 71-74 Comet (7/16" x 3 1/4" x 6 3/4")
AMK3441...(12 pc).....26.95
 75-77 Maverick & Comet (7/16" x 2 1/2 x 6 1/8")
D5DZ5705A...(ea).....10.95

REAR SHACKLE KIT



70-77 Maverick & 71-77 Comet
35117...(3 1/2" center to center...ea).....65.00
 74-77 Maverick & Comet
35148...(4" center to center...ea).....55.00

REAR SPRING/SHACKLE BUSHINGS



71-77 Maverick & Comet
C4GY5781A...(ea).....6.00
18988A...(8 pc).....30.00

SHOCKS - MONROE BRAND



70-77 Maverick & 71-77 Comet
 Monro-Matic by Monroe
33059...(front).....32.00
32103...(rear).....35.00

REAR SHOCK UPPER MOUNT BOLT



71-77 Maverick & Comet – (Must re-use OEM spacer)
B13375...(1/2"-13 x 2 3/4"...pr).....10.00
B12797...(nut - 6 pkg).....5.00

REAR AXLE HOUSING GASKET

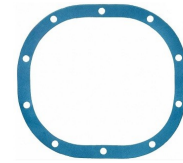

70-77 Maverick & 71-77 Comet
 - w/8" Housing
RDS13270.....5.00

DIFFERENTIAL CARRIER WASHERS



71-77 Maverick & 71-77 Comet
AMK1165...(10 pc).....5.00

REAR AXLE VENT



70-77 Maverick & 71-77 Comet
 - Vents axle and secures rear brake hose to differential
B10335...(2 1/8" x 7/16-20).....12.00

PINION BEARING OIL SEAL



70-77 Maverick & 71-77 Comet (all with 8" ring gear)
8181NA...(ea).....14.50

DIFFERENTIAL PINION NUT



70-77 Maverick & 71-77 Comet
B10471.....5.25

REAR AXLE BUMPER



70-74 Maverick & 71-73 Comet
 - (2) Required
C6AZ4730A...(ea).....8.00

Tools

DOOR PANEL REMOVER TOOL



TOOL7999.....10.50

BULB PLIERS



TL-102.....19.95

HUB BEARING DUST CAP INSTALLER



- For Installing B5A1131A Bearing Dust Caps
TOOL1131.....12.95

HEADLINER INSTALLATION TOOL



TOOL7672.....10.95
956300...(w/wood handle).....16.00

WINDSHIELD TOOL



87-6364.....2.50

IGNITION BEZEL TOOL



70 Maverick w/Non Locking Column
- For removing/tightening bezel nut
T-109-CL.....18.00

HOG RINGS & PLIER SET



w/Approx. 100 Rings
PLIERSETP.....22.00

SPORTLAMP SWITCH BEZEL NUT TOOL



T-65.....18.00



Melvin's Classic
Ford Parts
PHONE: 770-761-6800



Tools

WINDSHIELD WIPER ARM REMOVAL TOOL



20907.....10.00

REMOTE MIRROR NUT REMOVAL TOOL



All years w/remote drivers side sport mirror
- Prevents scratches to chrome nut and painted door
14963...(ea).....18.95

GLASS RETAINER CLIP TOOL



Used to install window molding clips. Helps prevent
scratches to painted surface of vehicle.
13574...(ea).....26.99

MULTI-TOOL



TL1002.....\$15.00

WINDOW MOLDING REMOVAL TOOL



KD2038.....19.95

STEERING WHEEL PULLER



GR5891.....10.50



UPS NEXT DAY & 2nd DAY AIR AVAILABLE

**VISIT US ON THE WEB AT:
WWW.MELVINSCCLASSICFORDPARTS.COM**

Transmission

TRANSMISSION PAN - CHROME



70-77 Maverick & 71-77 Comet
C4 Transmission
C5ZZ7A194A30.00

TRANSMISSION PAN GASKET



70-77 Maverick & 71-77 Comet
C4 Transmission
FG119.....6.00

TRANSMISSION FILTER KIT

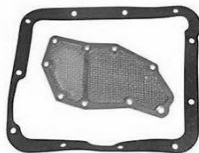

70-77 Maverick & 71-77 Comet
FK26422B.....10.50

TRANSMISSION OIL PAN BOLTS



x11

70-77 Maverick & 71-77 Comet w/C4
AMK1621...(11 pc).....5.00

TRANSMISSION INSPECTION PLATE



70-77 Maverick & 71-77 Comet
C4 Transmission
C5DZ7986B...(250-302).....14.00
C5DZ7986C...(chrome...250-302).....18.00
C5DZ7986A...(170-200).....27.95
C5AZ7986A...(FMX).....26.00

SPEEDOMETER CABLE & HOUSING w/Grommet



70-72 Maverick & 71-72 Comet w/MT
75 Maverick & Comet w/MT
76-77 Maverick & Comet (from 2/75) w/MT/AT
C9ZZ17260A...(60").....25.00
71-75 Maverick & Comet (Before 2/75) w/AT
C9ZZ17260B...(76").....25.00

SPEEDOMETER CABLE GROMMET



70-77 Maverick & 71-77 Comet
380634S...(ea).....2.50

SPEEDOMETER CABLE LUBE



- Prevents, Eliminates wear & noise
- Place on cable prior to inserting cable into sleeve
B5A19581A.....3.00

SPEEDOMETER CABLE RETAINER



70-77 Maverick & 71-77 Comet
- Secures cable at Transmission crossmember
373829.....3.95

SPEEDOMETER CABLE TO TRANS. CLAMP



70-77 Maverick & 71-77 Comet
- Secures speedometer cable to transmission
B9TZ17264.....5.00

**VISIT US ON THE WEB AT:
WWW.MELVINSCCLASSICFORDPARTS.COM**

Transmission

SPEEDOMETER CABLE GEAR – (RH TILT)



70-77 Maverick & 71-77 Comet
 Colors listed are for reference only, All of our gears are White in color
C0DD17271A...(maroon...16 teeth).....15.00
C3DD17271B...(white...17 teeth).....15.00
C0DD17271B...(yellow...18 teeth).....15.00
C0DD17271C...(pink...19 teeth).....15.00
C1DD17271A...(black...20 teeth).....15.00
C4OZ17271A...(red...21 teeth).....15.00

SPEEDOMETER CABLE GEAR RETAINER



70-77 Maverick & 71-77 Comet
 - All Transmissions
C1DZ17292A.....3.00

SPEEDOMETER DRIVE GEAR



70-77 Maverick & 71-77 Comet
C5ZZ17285A...(nylon, pink, 6 teeth).....25.00
C4ZZ17285A...(nylon, black, 7 teeth).....20.00
C8OZ17285B...(nylon, brown, 8 teeth).....35.00

TRANSMISSION DIPSTICK TUBE



70-74 Maverick & 71-74 Comet
 C4 Transmission
C6OZ7A228B.....18.00

TRANSMISSION DIPSTICK



70 Maverick 170/200 Only
 C4 Transmission
C6AZ7A020B.....15.75

TRANSMISSION CROSSMEMBER



71-76 Maverick & Comet C4, 3 SPD
160349.....89.95

TRANSMISSION MOUNT



70-77 Maverick & 71-77 Comet
2253.....18.00

BELLHOUSING SPACER PLATE



70-76 Maverick & 71-76 Comet w/Automatic
C5DZ7007B.....58.00
 77 Maverick & Comet
C9DZ7007B...(302 w/164 tooth flexplate).....58.00

FLEXPLATES



70-77 Maverick & 71-77 Comet
 170/200 6 Cyl w/C4
C3DZ6375B.....45.00
 72-76 Maverick & Comet
 302 (V8) w/C4 and 157 Teeth
C3AZ6375L.....55.00
 77 Maverick & Comet
 302 (V8) w/C4 and 164 Teeth
E0AZ6375A.....69.50



Transmission

TORQUE CONVERTER FLANGE NUTS



x4

70-77 Maverick & 71-77 Comet
- Secures Torque Converter to Flex Plate
AMK185...(4 pc).....5.00

FLYWHEEL/FLEXPLATE BOLTS



AMK1839 x6



AMK1840 x6

70-77 Maverick & 71-77 Comet
AMK1839...(7/16"-20 x 15/16" - w/ manual trans.).....15.75
AMK1839...(7/16"-20 x 15/16" - C4 w/reinforcement ring).....15.75
AMK1840...(7/16"-20 x 3/4" - C4 w/o reinforcement ring).....15.75

SHIFT LINKAGE REPAIR KIT



70-76 Maverick & 71-76 Comet
C5ZZ7285RPK2.....20.00

TRANSMISSION LINKAGE CLIP



70-77 Maverick & 71-77 Comet
352358S...(ea)......79

TRANSMISSION COOLER LINES - (**Oversize S/H**)



72 Maverick & Comet
302 (V8) Trans. Cooler Lines
LTC7201...(2 pc...ea).....55.00
LTC7201S...(stainless steel...ea).....85.00
75 Maverick & Comet
302 (V8) Trans. Cooler Lines
LTC7501...(2 pc...ea).....55.00

**VISIT US ON THE WEB AT:
WWW.MELVINSCLASSICFORDPARTS.COM**

TRANSMISSION OIL COOLER LINE FITTINGS



70-77 Maverick & 71-77 Comet
359279S...(pr).....6.50

TRANSMISSION OIL COOLER LINE CLIPS



70-77 Maverick & 71-77 Comet
C5ZZ7A032...(pr).....5.95

TRANSMISSION VACUUM LINE



72 Maverick & Comet
302 (V8) Trans. Vacuum Line
LTV7201...(ea).....25.00
LTV7201S...(stainless steel...ea).....30.00

TRANSMISSION VACUUM MODULATOR



71-72 Comet w/302 & FMX Trans.
C1AZ7A337B...(threaded).....35.00
70-72 Maverick & 71-72 Comet - All 6 cyl & 302 w/C4 Trans.
C4AZ7A377B...(threaded w/white stripe).....25.00
72-77 Maverick & Comet - All 6 cyl & 302 w/C4 Trans.
D2AZ7A377A...(dual port push-in w/red stripe).....50.00
73-75 Maverick & Comet - All 6 cyl & 302 w/C4 Trans.
D3OZ7A377A...(push-in w/yellow stripe).....20.00
73-77 Maverick & Comet - Used by most Rebuilders
D5AZ7A377B...(push-in w/green stripe).....20.00

***** PRICES ARE SUBJECT TO CHANGE*****

See disclaimer in front of catalog. Refer to website for current pricing. Confirm prices upon ordering.

Transmission

SHIFT LEVER/LINKAGE BUSHING



70-77 Maverick & 71-77 Comet
 - Used in various locations to secure linkage rods
E0SZ7341B...ea.....4.95

KICK DOWN CONTROL SHAFT SPRING



70-77 Maverick & 71-77 Comet
D1AZ7146...ea.....8.00

SHIFT SHAFT SEAL



70-77 Maverick & 71-77 Comet (all w/C4)
240816...ea.....7.50

NEUTRAL SAFETY SWITCH



71-72 Maverick & Comet
SW1615.....60.00

FRONT PUMP SEAL



70-77 Maverick & 71-77 Comet
 Fits C4 & FMX
NAT331107N...ea.....6.00

BUSINESS HOURS
TUES-FRI 8:30-5:00
SATURDAY 8:30-2:00
CLOSED SUNDAY AND
MONDAY
EASTERN STANDARD TIME

AUTOMATIC TRANSMISSION REBUILD KIT



70-77 Maverick & 71-77 Comet
 Fits C4 Automatic
D0ZZ7005MK...ea..... Call

EXTENSION HOUSING BUSHING w/SEAL



70-77 Maverick & 71-77 Comet
 Fits C4 and 3 Speed 6 cyl & V8
5202...ea.....21.95

OUTPUT SHAFT OIL SEAL



70-77 Maverick & 71-77 Comet
 Automatic & Manual Transmissions
7692S...ea.....13.95

MANUAL TRANSMISSION GASKET SET

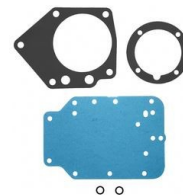

70-77 Maverick & 71-77 Comet
 Fits "RAN" manual transmission 6 cyl & V8
TS80108...set.....9.50

MANUAL TRANSMISSION REBUILD KIT



70-77 Maverick & 71-77 Comet
 Fits "RAN" manual transmission, 6 cyl & V8
C5ZZ7005-R3...ea.....99.95

Transmission

TRANSMISSION GEAR-REVERSE IDLER



70-77 Maverick & 71-77 Comet
Fits all except 170
C5AZ7141C.....119.95

TRANSMISSION GEAR-LOW CONSTANT MESH



70-72 Maverick & 71-72 Comet
C5AZ7A029C.....149.95

TRANSMISSION GEAR-LOW & REVERSE GEAR



71-77 Maverick & 71-77 Comet
C6AZ7124B.....149.95

TRANSMISSING COUNTER SHAFT CLUSTER



70-74 Maverick & 71-74 Comet
C5AZ7113G.....159.95



DRIVE SHAFT U-BOLT - (For 1-1/8 Bearing Caps)



70 to 5/1/72 Maverick & 71 to 5/1/72 Comet
C1AZ4529A...(5/16-24...pr).....8.95
72-77 Maverick & Comet (after 5/1/72)
D3AZ4529C...(5/16-18...ea).....4.49

DRIVESHAFT YOKE



70-72 Maverick & 71-71 Comet
28 spline w/outside lock
C3AZ4841D.....95.00

U-JOINT



70-77 Maverick & 71-77 Comet
UJ369...(V8 & 6 cyl, auto & manual, trans. end...ea).....21.00
UJ430...(V8 & 6 cyl, auto & manual, rear axle...ea).....21.00



Trunk

TRUNK WEATHERSTRIP SEAL

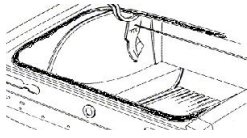

70-77 Maverick & 71-77 Comet
D0DZ6243720..... 30.00

TRUNK/DECK LID BUMPERS



70-77 Maverick & 71-77 Comet - (2 door models)
PE184...(pr).....3.50

TRUNK LIGHT - FACTORY STYLE



- Replacement w/Mercury Activated Switch
 70-77 Maverick & 71-77 Comet
68-TRUNK-CPE-CV...(72").....45.00

TRUNK COMPARTMENT LIGHT



70-72 Maverick & 71-72 Comet
 - Dealer Add-on - Can be added to any year
C2RZ15A700A...(ea).....25.00

TRUNK LATCH



70-77 Maverick & 71-77 Comet
C5AZ6243200A.....32.95

TRUNK LID CATCH



70-77 Maverick & 71-77 Comet
3649X.....15.00

TRUNK LOCK



70-77 Maverick & 71-77 Comet
 - Must re-use O.E. Retainer
C7AZ6543505A.....18.95

TRUNK LOCK STEM



70-77 Maverick & 71-77 Comet
C7ZZ6543283A.....4.25

TRUNK LOCK RETAINER



70-72 Maverick & 71-72 Comet
 Used until 3/1/72
C5AZ6222023A.....3.00

TRUNK LOCK GASKET



70-77 Maverick & 71-77 Comet
C7AZ6243625A.....1.50

TRUNK LOCK w/CONSOLETTA LOCK



- This kit contains a trunk lock with matching consolette lock allowing the use of a single key for both.
C9ZZ6506072K.....35.00

****NOTE -Consolette lock does NOT replace the glove box lock on Mavericks & Comets equipped with a glove box.**

**VISIT US ON THE WEB AT:
WWW.MELVINSCLASSICFORDPARTS.COM**

Trunk

FUEL FILLER PIPE TO TRUNK FLOOR SEAL



71-77 Maverick & Comet
D1ZZ9008.....23.95

TRUNK FLOOR GROMMETS



70-77 Maverick & 71-77 Comet
383796S...(2 1/4" wide...2 Req...ea).....2.75

71-77 Maverick & Comet
377949S...Trunk Floor...7/8" wide (1 req...ea).....1.25

TRUNK FLOOR METAL PLUG



71-77 Maverick & Comet
C8ZZ651117...(1 Req...ea).....6.00

SPARE TIRE BOLT BRACKET



- Must be spot welded to trunk floor
C7AZ6547076.....7.95

SPARE TIRE MOUNTING NUT & J BOLT



70-77 Maverick & 71-77 Comet
C8AZ1462A...(nut).....3.00
C9ZZ1448B...(j-bolt).....15.00

***** PRICES ARE SUBJECT TO CHANGE *****

See disclaimer in front of catalog. Refer to website for current pricing. Confirm prices upon ordering.

TRUNK FLOOR BOARD



1970 Maverick
FAM-704.....5.00

TRUNK MAT



1970 Maverick
TM70MAV...(speckled vinyl).....54.50



71-75 Maverick & Comet, will fit 71-77 Maverick & Comet
TM71MAV...(plaid).....69.95



76-77 Maverick & Comet, will fit 71-77 Maverick & Comet
TM76MAV...(gray felt).....49.95

JACK ASSEMBLY



70-77 Maverick & 71-77 Comet
C5ZZ17080R.....90.00

JACK HANDLE - FOLDING TYPE



70-77 Maverick & 71-77 Comet
C5ZZ17032.....26.50

Trunk

TIRE COVERS



70-77 Maverick & 71-77 Comet
 TC2...(plaid).....20.00
 TC3...(black).....20.00

TOTE BAG



70-77 Maverick & 71-77 Comet
 TB3...(small plaid).....25.00
 TB1...(large plaid).....25.00
 TB4...(small black).....25.00
 TB2...(large black).....30.00

TOOL KIT BAG



70-77 Maverick & 71-77 Comet
 TK-FM-PLD...(plaid).....13.95

REAR MARKER LIGHT STUD PROTECTORS



70-77 Maverick & 71-77 Comet
 PE222...(4 pc).....3.00

INNER TRUNK BRACKET/BRACE



70-73 Maverick & 71-73 Comet
 - Replacement for 70-73 and a must if converting to small rear bumper
 on 74-77 Maverick and Comet - fits LH & RH
 MM634LR...(ea).....15.00

TRUNK DIVIDER - (Oversize S/H)



70-77 Maverick & 71-77 Comet
 FAM-182.....21.95
 TKD-025...(w/luxury décor-w/jute).....40.00



**Melvin's Classic
 Ford Parts
 PHONE: 770-761-6800**



Weatherstripping

RADIATOR SUPPORT TO HOOD SEAL w/CLIPS



70-77 Maverick & 71-77 Comet
D0DZ16238.....21.95

HOOD TO COWL SEAL



73-77 Maverick & Comet
D3DZ16740.....16.95

WINDSHIELD GASKET



70-77 Maverick & 71-77 Comet
 * Fits 2-Door & 4-Door Models
D2DZ6203110A.....75.00

STEERING COLUMN TO FIREWALL SEAL



70-77 Maverick & 71-77 Comet
D0DZ6201738.....14.95

DOOR WATERSHIELDS



- Clear plastic sheeting, goes between door panel and door.
 Bottom edge tucks inside door when installing
 70-73 Maverick & 71-73 Comet
FAM261...(pr).....18.95
 74-77 Maverick & Comet
FAM260...(pr).....18.95

ROOF RAIL SEALS

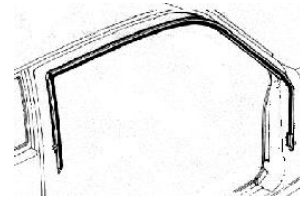

70-77 Maverick & 71-77 Comet
 - 2 Door models Only
D0DZ26251222...(pr).....125.00

DOOR GLASS RUN



70-77 Maverick & 71-77 Comet
 - 2 Door models only, (will fit 4 Door, trimming will be required)
D1DZ5421596...(ea).....25.00



Weatherstripping

DOOR FELT/BELTLINE WEATHERSTRIP



70-77 Maverick & 71-77 Comet
 - Made for 2 Door Models, attaches to door on each side of glass.
MA101...(4 pc).....85.00

DOOR SEALS

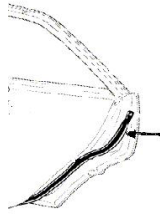

70-77 Maverick & 71-77 Comet
 - 2 Door models only, (will fit 4 Door, trimming will be required)
D0DZ6220530...(pr).....75.00

WEATHERSTRIP RETAINER



70-77 Maverick & 71-77 Comet
 - Secures roofrail weatherstrip to vehicle.
B10766...(10 pkg).....3.50

WEATHERSTRIP RETAINER

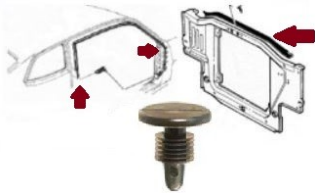

70-77 Maverick & 71-77 Comet
 - Secures Radiator Support Seal to top of Radiator Support.
 - Also used to secure the ends of the roofrail weatherstrip.
FA3832...(ea)......75



QUARTER WINDOW SEALS

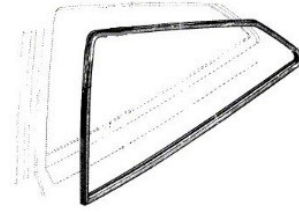

73-76 Maverick & Comet
D3DZ6230248PR.....95.00

REAR WINDOW GASKET

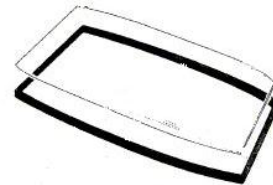

D0DZ6242084...(2 door).....55.00
D1DZ5442084...(4 door).....60.00

TRUNK WEATHERSTRIP SEAL

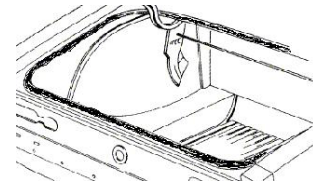

70-77 Maverick & 71-77 Comet
D0DZ6243720.....30.00

WEATHERSTRIP KIT



70-77 Maverick & 71-77 Comet – 2 Door Models
 Kit includes: Windshield & Rear Window gaskets, Hood to Cowl Seal,
 Door Seals, Felt, Glass Run, Roof Rail & Trunk Seals.
D2DZ62KIT.....475.00

**VISIT US ON THE WEB AT:
WWW.MELVINSCCLASSICFORDPARTS.COM**

Weatherstripping

QUARTER PANEL EXTENSION SEALS



70-77 Maverick & 71-77 Comet
 *Must split to make pair
D0MZ16130.....4.50

PARKING LIGHT LENS GASKETS



70-72 Maverick w/below bumper mounted
D0DZ13211A...(pr).....6.95
 71-74 Maverick & Comet w/Grille Mounted Lights
C9WY13211A...(pr).....4.00

TAILLIGHT TO BODY GASKET



70-77 Maverick
D0DZ13420B...(pr).....9.95
 71-77 Comet
D0GY13A495D...(pr).....12.95

TAILLIGHT LENS GASKET



70-77 Maverick
D0DZ13461B...(pr).....4.95
 71-77 Comet
D0GY13461B...(pr).....10.95

**VISIT US ON THE WEB AT:
WWW.MELVINSCCLASSICFORDPARTS.COM**

REAR MARKER LIGHT LENS GASKETS

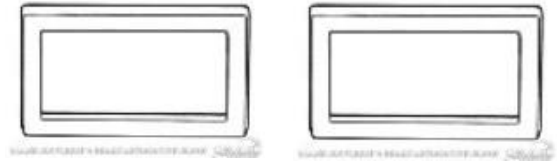

70-77 Maverick & 71-77 Comet
D0ZZ15209...(pr).....2.00

REAR MARKER LIGHT TO BODY GASKET



70-77 Maverick & 71-77 Comet
D1DZ15A447A...(pr).....9.95

REAR BUMPER BRACKET TO BODY PADS



70-73 Maverick & 71-73 Comet
C5ZZ6540996...(4 pc).....2.00

REAR LICENSE LAMP LENS GASKET



70-76 Maverick & 71-76 Comet
C7AZ13568A.....1.00



Wheels

MAGNUM 500 WHEELS - (**Over**size S/H)



70-77 Maverick & 71-77 Comet

- All 5 Lug Applications

Call with Application

14X6MAGNUM...(ea).....	175.00
14X7MAGNUM...(ea).....	189.00
15X7MAGNUM...(ea).....	195.00
15X8MAGNUM...(ea).....	199.00

WHEEL CENTER CAP - MAGNUM 500



All Magnum 500 Wheels

C9OZ1130BLK...(black...ea).....	40.00
C9OZ1130RED...(red/white/blue...ea).....	40.00
D6OZ1130R...(red/black center...ea).....	40.00
C7WY1130BK...(black-mercury head...4 pc).....	130.00
C7WY1130BLU...(blue-mercury head...4 pc).....	130.00
C7WY1130RED...(red-mercury head...4 pc).....	130.00

MAGNUM 500 SPINNERS



1130SET...(4 pc).....	145.00
-----------------------	--------

**VISIT US ON THE WEB AT:
WWW.MELVINSCLASSICFORDPARTS.COM**

MAGNUM 500 WHEEL - PAINT DECAL

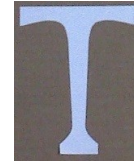

Apply to chrome section of wheel when repainting

1 pkg. covers 2 wheels

70-77 Maverick & 71-77 Comet w/ Magnum 500 wheels

FAM-748.....	15.95
--------------	-------

STYLED STEEL WHEELS - (**Over**size S/H)



70-77 Maverick & 71-77 Comet

All 5 Lug Applications

Call with Application

65SSWHEEL...(14x5...ea).....	179.95
14X7SSWHEEL...(14x7...ea).....	185.00
15X7SSWHEEL...(15x7...ea).....	185.00

WHEEL CENTER CAP



For Styled Steel Wheels

C6OZ1130L...(ea).....	50.00
-----------------------	-------

**BUSINESS HOURS
TUES-FRI 8:30-5:00
SATURDAY 8:30-2:00
CLOSED SUNDAY AND
MONDAY
EASTERN STANDARD TIME**

Wheels

STYLE STEEL WHEEL - 15"



70-77 Maverick & 71-77 Comet
 All 4 lug applications (By Legendary Wheel Co)
LW40-50644A...(Black...ea).....165.00
LW40-50644B...(Gray...ea).....165.00

WHEEL CENTER CAP



70-77 Maverick & 71-77 Comet
 For use w/4 lug Legendary wheels
LW-HC006...(Red...ea).....35.00
LW-HC007...(Black...ea).....35.00

HUBCAPS - 14"



70-77 Maverick & 71-77 Comet
C5ZZ1007HCS...(set of 4).....155.00

WHEEL CENTER DECAL



70-77 Maverick & 71-77 Comet
 All requiring use of a center cap
DF1447...(black w/Ford oval...ea).....4.00

LUG NUTS



- For Magnum 500 Wheels
C9ZZ1012...(ea).....1.85
 - For Standard Wheel
8744...(ea)......65

VALVE STEM CAPS



Ford Script –
ACC5033260...(blue...4 pc).....18.00

WHEEL STUDS



70-77 Maverick & 71-77 Comet
 - Rear
27832B...(70-73).....CALL
6184B...(74-75).....CALL
27856B...(76-77).....CALL
 - Front
27781B...(70-73).....CALL
27833B...(74-77).....CALL



UPS NEXT DAY & 2nd DAY AIR AVAILABLE

Wipers

WASHER BOTTLE



70-77 Maverick & 71-77 Comet
C9OZ17618B.....95.00

WASHER RESERVOIR PUMP



70-77 Maverick & 71-77 Comet
C9AZ17664A.....20.00

WASHER TEE / "F"



70-77 Maverick & 71-77 Comet
PE701...(all except 1972).....2.00
C8OZ17A601A...(1972 only).....2.00

WIPER WASHER NOZZLE SCREWS



70-77 Maverick & 71-77 Comet
 Also used to secure washer "F" to firewall
AMK855...ea.....1.35

WINDSHIELD WASHER HOSE & TEE / "F" KIT



70-77 Maverick & 71-77 Comet
 - Trim to fit
C9ZZ17543K.....7.50

WIPER ARMS



70-77 Maverick & 71-77 Comet
C6ZZ17526...(polished...ea).....16.95
C6ZZ17526S...(satin...ea).....17.95

WIPER BLADE - (16")



70-77 Maverick & 71-77 Comet
D4AZ17528...(ea).....16.00

WIPER BLADE REFILLS



70-77 Maverick & 71-77 Comet - (16")
C9AZ17593A...(pr).....12.00

WIPER PIVOT SHAFT SEALS



70-77 Maverick & 71-77 Comet
C5ZZ17A475B...(rubber...pr).....3.00
C7ZZ17A475BL...(leather...pr).....15.00



Wipers

WINDSHIELD WIPER KNOB - OPTIONS



70-77 Maverick & 71-77 Comet

- D3OZ17513B...(chrome plastic, octagon shape).....12.95
- E5TZ17513A...(black plastic, octagon shape).....25.00
- D3OZ17513...(chrome plastic, octagon shape).....25.00
- C4AZ17513A...(correct for 65 Mustang - see pg. 30).....8.50

WIPER MOTOR - REPLACEMENT



70-77 Maverick & 71-77 Comet

NOTE: This wiper motor has different wire colors than original. Remove Original plug and wires from your old wiper motor and connect wiring: Blue wire on new motor to Blue wire on original plug/harness
Green wire on new motor to White wire on original plug/harness
Red wire on new motor to Red wire on original plug/harness
White wire on new motor to Black wire on original plug/harness
Black wire on new motor is just an additional ground, connect to bracket.

- C7ZZ17508.....89.95

WIPER MOTOR GEAR COVER



70-77 Maverick & 71-77 Comet

- C3AZ17A511C.....11.95

WIPER MOTOR ARM



70-77 Maverick & 71-77 Comet

- 3623A.....20.00



WIPER ARM LINKAGE CLIP



70-77 Maverick & 71-77 Comet

- C5ZZ17531A.....3.00

WIPER SWITCH



73-77 Maverick & Comet
- w/o Intermittent Wipers

- D1ZZ17A553A.....35.00

70-77 Maverick & 71-77 Comet

- w/Intermittent Wiper Conversion- Switch alone does not provide intermittent wiper function. Correct/years for Ford Trucks/Broncos. These have Blades, not Pins.



- D10Z17A553A...(73-79).....85.00

- E7TZ17A553A...(80-91).....125.00



*****PRICES ARE SUBJECT TO CHANGE*****

See disclaimer on front of catalog. Refer to website for current pricing. Confirm prices upon ordering.

C4 TRANSMISSION MANUAL ON CD



CD10175.....25.00

HOW TO REBUILD SMALL BLOCK FORD ENGINES

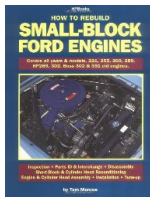

101863...(158 pages).....21.95

FORD AUTO. TRANS. OVERHAUL MANUAL

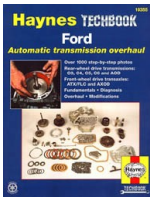

208 PAGES - HAYNES
134615...(C3, C4, C5, C6 & AOD).....26.95

HOW TO REBUILD FORD V8 ENGINES

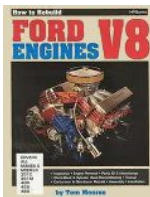

101934...(160 pages).....25.00

HOW TO REBUILD THE SMALL BLOCK FORD – REVISED

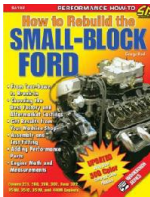

Step-By-Step thru a rebuild - The essential guide to rebuilding
149216.....30.00

FMX TRANSMISSION MANUAL ON CD

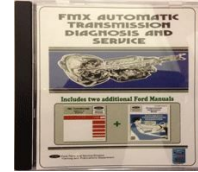

CD10174.....25.00

FORD MASTER PARTS CATALOG ON DVD



Covers years 65-72
FD10.....26.95

FORD MASTER PARTS & ACCESSORIES ON CD



Covers years 73-79
CD10011.....26.95

FORD SHOP MANUALS ON CD



CD10007...(1970).....25.00
CD10008...(1971).....25.00
CD10009...(1972).....25.00
CD10010...(1973).....25.00

****Owners Manuals**, often we can get used owners manuals for the Maverick & Comet, call us with your year and model and we will be glad to check availability and pricing for you.



Index

A/C Accumulator/Drier	5	Apron, RH Inner Fender - Option	103
A/C Blower Motor Resistor	5	Argent Spray Paint	91
A/C Box Clip	6, 18	Armrest Base	36, 82
A/C Cable Clamp & Screw	6	Armrest Clip	19, 36, 82
A/C Compressor	3	Armrest Pad Screws	36, 82
A/C Compressor Clutch Brush Set	3	Armrest Pads	36, 82
A/C Compressor Cover	3	Ash Tray	74
A/C Compressor Crankshaft Oil Seal	3	Ash Tray Bumper	29, 81, 99
A/C Compressor Mounting Bracket	3	Auto Column Shift Knob	28
A/C Compressor Support Brace	3	Auto Floor Shift Knob Set Screw	27
A/C Compressor Switch	3	Auto Shift Housing Bolt Plug	27
A/C Compressor Tag	3	Auto Shift Housing to Floor Seal	26
A/C Condenser	4	Auto Shift Lever Lockout Spring	28
A/C Controls Micro Switch	5	Auto Shifter Knob Button	27
A/C Crankshaft Pulley	4	Auto Trans Floor Shift Cover	26
A/C Drain Hose Clamp	6	Auto Trans Selector Dial Rubber Seal	27
A/C Drain Hose Grommet	6, 100	Auto Trans. Shift Cover Hardware	26
A/C Expansion Valve	5	Automatic Floor Shifter Knob	27
A/C Fresh Air Inlet Gasket	6	Automatic Shifter Indicator	28
A/C Hoses	4	Axle Bearing & Race	11
A/C Idler Pulley	3, 45		
A/C Line Grommet	4, 100	Backing Plate Hardware	11
A/C Quick Disconnect Fitting	5	Back-Up Lamp Socket	41, 87
A/C Service Valve	4	Battery	7
A/C Service Valve Caps	4	Battery "J" Bolt	7
A/C Thermostat	5	Battery "Sta-Ful" Decal	8
A/C Vacuum Canister	5	Battery Box Relocation Kit	1, 8
A/C Vacuum Control Motor	5	Battery Cables	7
A/C Vacuum Switch	5	Battery Cable to Solenoid Bracket	8
A/C Ventilation Hose	6	Battery Clamp	8
Accelerator Cable	56	Battery Clamp J Bolt	7, 60
Accelerator Pedal	56, 80	Battery Corrosion Protectors	8
Accelerator Pedal Bolt	56	Battery Disconnect Switch	8
Accelerator Pedal Spring	56	Battery Holddown Clamp	7
Accelerator Retracting Spring	56	Battery Mat	7
Accessories	1-2	Battery Positive Terminal Tag	8
Adhesive Cleaner-Remover	94	Battery Tag	8
Aftermarket Emblems	1	Battery Tender Charger	8
Air Cleaner	45	Battery Test Ok Decal	8
Air Cleaner Heat Shroud	45	Battery Top Cover	7
Air Cleaner Lid Gasket	45	Battery Tray Hardware	7
Air Cleaner Snorkel Hot Air Tube	45	Battery Tray	7
Air Cleaner Snorkel Spring	45	Battery Tray Reinforcement Plate	7, 102
Air Cleaner Wing Nut	45	Bellhousing Spacer Plate	22, 117
Air Conditioning	3-6	Blower Motor Resister Nylon Rivot	73
Alternator	46	Blower Motor Resistor	5, 42
Alternator Adjustment Bracket	46	Blower Motor Wheel	72
Alternator Fan	46	Body Bolts	65
Alternator Harness	41	Body Seam Sealer	93
Alternator Pulley	46	Brace/Bracket, Inner Trunk Bottom	103, 123
Alternator Spacer	46	Bracket, Spare Tire Bolt	122
Alternator Splash Shield	46	Brake Adjustment Hole Plug	10, 100
Antenna	54, 97	Brake Bleeder Screw	11
Antenna Cable Clip	19, 97	Brake Booster Check Valve	14
Antenna Cable Grommet	97, 100	Brake Cable Backing Plate Seal	15
Apron to J Bolt Bracket	7		

Index

Brake Calipers	12	Clutch Linkage Rod Retainer Clip	19, 23
Brake Cylinder Banjo Bolt	13	Clutch Pedal Bumper	25, 99
Brake Distribution Block	14	Clutch Pedal Pad	25
Brake Distribution Valve Rebuild Kit	14	Clutch Pedal Pad Trim	25
Brake Drum	9	Clutch Pedal Return Spring	25
Brake Drum Retainer	9	Clutch Pedal Rod Firewall Seal	23
Brake Drum Upgrade Kit	11	Clutch Pedal Roller Bearing Kit	24
Brake Hose Clip	13, 19	Clutch Pedal Shaft Bushing	24
Brake Hoses	13	Clutch Pedal Support Repair Kit	24
Brake Hub	11	Clutch Pivot Dust Grommet	23, 100
Brake Lamp Switch	15, 38	Clutch Pressure Plate Bolts	22
Brake Line Clip	13, 19	Clutch Release Bearing	22
Brake Line/Shock Tower Grommet	13, 101	Clutch Release Equalizer Shaft Ball	23, 24
Brake Lines	12, 13	Clutch Release Lever Bracket	22
Brake Pedal Pad	16	Clutch Release Lever Dust Boot	23
Brake Pedal Trim	16	Clutch Release Lever Idler Swivel	23
Brake Pressure Valve Lamp Switch	14	Clutch Release Lever Spring	23
Brake Push Rod - Adjustable	14	Clutch Rod	23
Brake Rotor	12	Clutch Rod Bushing	23
Brake Shaft Pedal Bushing	15	Clutch Rod Retainer Spring	23
Brake Shoe Hardware Kit	9	Clutch Shaft Ball Clip	24
Brake Shoe to Cylinder Link	11	Coil Harness Pigtail	39
Brake Shoes	9	Coat Hook	74
Brake Valve - Adjustable	14	Coil Bracket	46
Brake Pedal Shaft Spring Clip	15, 19	Console / Shifter	26-28
Brakes	9-16	Console-Humphugger	2
Brass Freeze Plugs Kit	47	Consolette Clock Harness Pigtail	26, 38
Break In Oil	51	Consolette Door Bumpers	26, 99
Bucket Seat Upholstery	78	Consolette Door Hardware	26
Bulbs	83-84	Consolette Lock	26, 88
Bumper Bolts	66	Control Valve Ball Stud Brass Socket	105
Bumper Guard Pads	54	Control Valve Seal Kit	105
By-Pass Hose	96	Cooler	1
		Cowl Repair Panels	102
Cam Bolt & Nut Kit	111	Cowl Vent Repair Kit	54
Car Cover Antenna Grommet	1, 101	Crossmember	112, 117
Car Duster	1		
Carburetor Gasket	56	Dash	29-30
Carburetor Rebuild Kit	56	Dash Knobs	30
Carpet	74	Dash Pad Cover	29, 81
CD Player	98	Dash Pad Hardware	29, 81
Center Caps	128, 129	Dash Speaker	30, 98
Center Link	107	Dash Speaker Hardware	98
Choke Tube	46	Dash Spray Paint	91
Cigarette Lighter	29	Decals	31-34
Clips & Retainers	17-21	Decklid Bumpers	100, 121
Clutch	22-25	Defogger Motor Wiring Insulator	44
Clutch Equalizer Bar Ball Clip	19, 24	Defroster Control Cable	73
Clutch Equalizer Bar Bracket	23	Differential Carrier Washers	113
Clutch Equalizer Bar Bushing Kit	24	Differential Pinion Nut	113
Clutch Equalizer Bar Repair Kit	24	Dimmer Switch Cover	74, 85
Clutch Equalizer Rod Shaft Ball	24	Dimmer Switch Grommet	74, 85, 101
Clutch Fork	22	Dipstick	51, 117
Clutch Kit	22	Dipstick Tube	51, 117
Clutch Lever Shaft Repair Kit	24	Disc Backing Plate Gaskets	12

Index

Disc Brake Conversion Kit	12	Exhaust Chock Stove Rebuild Kit	46
Disc Brake Pads	12	Exhaust Do-Nut Gasket	53
Distributor Cam Lube	93	Exhaust Headers	53
Distributor Holddown	46	Exhaust Manifold Bolts	53
Distributor Primary Wire	39	Exhaust Manifold Gasket	53
Distributor Vacuum Control Assembly	47	Exhaust Manifold Heat Shroud	45, 53
Dome Light Bezel	74, 85	Exhaust Paint	53, 92
Dome Light Lens	74, 85	Extension Housing Bushing & Seal	119
Door Beltline Weatherstrip	125	Exterior	54-55
Door Bumpers	37, 99		
Door Glass Retainer	20, 37	Fan Shroud Hardware	95
Door Glass Run	124	Fan Spacer	95
Door Handle Pads - Exterior	35, 54	Fender	102
Door Handles - Exterior	35, 54	Fender Cover	1
Door Handles - Interior	36, 82	Fender Emblem	54
Door Hinge Pin & Bushing	35	Filler Pipe to Body Gasket	57
Door Jamb Dome Light Switch	38	Filler Pipe to Tank Hose	58
Door Jamb Switch Socket	38	Firewall Insulator Pad	75
Door Latch Assembly	37	Flasher	43
Door Latch Repair Kit	37	Flexplates	117
Door Latch Rod Retainer Clip	19, 37	Floor Mats	74
Door Latch Screws	37	Floor Pan	102
Door Lock Gasket	37	Floor Pan Metal Plug	102
Door Lock Grommets	35, 88	Floor Shift Lever Cable	27
Door Lock Knob	35	Floor Shift Light Shield	26
Door Lock Lever	88	Floor Shift Light Diffuser	26
Door Lock Retainer	20, 37	Floor Shifter Boot	28
Door Mirror	89	Flywheel	22
Door Mirror Screws	90	Flywheel Ring Gear	22
Door Panel Boards	35, 81	Flywheel/Flexplate Bolts	22, 118
Door Panel Clips	19, 35, 81	Ford Master Parts Catalog on CD	131
Door Panels	35, 81	Ford Master Parts Catalog on DVD	131
Door Parts	35-37	Ford Shop Manuals on CD	131
Door Seals	125	Ford Transmission Overhaul	131
Door Skin, Universal Lower	102	Frame Support	48
Door Watershields	35, 124	Freeze Plug	47
Door/Trunk Lock Gasket	37, 121	Fresh Air Inlet Gasket	72
Doors	35-37	Front Chin Spoiler	54
Drive Shaft U-Bolt	120	Front Chin Spoiler Hardware	54
Driveshaft Yoke	120	Front Coil Spring Insulator	110
Duraspark Harness Pigtail	39	Front Coil Springs	110
		Front Crossmember	112
Electrical	38-44	Front Crossmember Bolts	112
Emblems	1, 54	Front Hub Grease Cap	11, 112
Engine	45-52	Front Pump Seal	119
Engine Bracket Bolt	64	Front Seat Track Latch Spring	79
Engine Compartment Light	41, 47, 87	Front Suspension Bumper	99, 110
Engine Oil	51	Front Valance	103
Engine Oil Dipstick	51	Fuel	56-59
Engine Paint	91, 92	Fuel Cap	57
Engine Rebuild Manual, Small Block	131	Fuel Cap Gasket	57
Engine Side Pivot - Equalizer Bar	23	Fuel Cap Lock	58
Engine/Bellhousing Spacer Plate	22, 117	Fuel Filler Pipe Screws	56
Equalizer Bar - Engine Side Mount	24	Fuel Filler Pipe to Body Gasket	57
Exhaust	53	Fuel Filler Pipe to Floor Seal	56, 122

Index

Fuel Filler Pipe to Tank Seal	56	Headliner Rod Retainers	75
Fuel Filter	57	Headrest	80
Fuel Hose	57	Headrest Guide & Retainer	80
Fuel Line Apron Grommet	57, 101	Heat Shield Exhaust Manifold Bolt	53
Fuel Lines	57	Heater	72-73
Fuel Preservative	59	Heater Assembly	72
Fuel Pump	57	Heater Assembly to Firewall Nuts	72
Fuel Pump Block Off Plate	57	Heater Blower Motor	42, 72
Fuel Sending Unit	58	Heater Blower Motor Resistor	42, 72
Fuel Sending Unit O Ring	59	Heater Box Clip	18, 72
Fuel Sending Unit Retaining Ring	59	Heater Box Seal Kit	72
Fuel Tank	58	Heater Cable Clamp & Screw	73
Fuel Tank Sealer	59, 92	Heater Control Knobs	30, 73
Fuel Tank Sending Unit Filter	58	Heater Control Valve	6
Fuel Tank Sending Unit Float	59	Heater Control/Clock Socket	42
Fuel Tank Strap Mounting Bolts	58	Heater Core	72
Fuel Tank Straps	58	Heater Core End Caps	72
Fuel Tank Vapor Valve	58	Heater Hose	73
Fuel Tank Vapor Valve Grommet	58, 101	Heater Hose Clamps	73, 96
Fulcrum Spacer - T-5 Conversion	25	Heater Hose Firewall Grommets	73, 100
Fuse Box Clip Repair Kit	40	Heater Hose to Block Connection	47
Fuses	40	Hood, "Grabber"	103
		Hood Bumpers	99
		Hood Insulation	52
		Hood Letters	54
		Hood Mounted Tachometer	55
		Hood Ornament	55
		Hood Pin Kit	55
		Hood Prop Rod Clip	20
		Hood Prop Rod Retainer	20
		Hood Scoop / Scoops	55
		Hood Scoop Grille	55
		Hood Scoop Hardware	55
		Hood to Cowl Seal	124
		Horn Assembly	38
		Horn Button	76
		Horn Button Center Emblem	77
		Horn Button Cover	77
		Horn Pad	76
		Horn Pad Cover	77
		Horn Ring	76
		Horn Switch	38, 76, 77
		Horn Switch Gap Cover	77
		Horn Switch Cover	76, 77
		Hubcaps	128
		Idler Arm	104
		Idler Arm Bushing	104
		Idler Pulley	3
		Ignition Coil	39
		Ignition Cylinder	88
		Ignition Solenoid	42
		Ignition Switch	39
		Ignition Switch Bezel	30
		Ignition Switch & Pigtail	39
Gas Cap	57		
Gasket Sealer	94		
Gear Shift Collar Pointer	28		
Gear Shift Lever Boot	28		
Glove Box Bumpers	29, 81, 99		
Glove Box Liner Screws	29		
Glove Box Liner	29, 81		
Grille Clip	20		
Grille to Stone Guard Grommet	101		
Hardware	60-71		
Harmonic Balancer	47		
Harmonic Balancer Hardware	47		
Harness Wrap	44		
Headlamp Dimmer Switch Cover	74		
Headlamp Switch Stem	30		
Headlight Adjusting Kit	84		
Headlight Bucket	85		
Headlight Bucket Bearing/Antirattler	84		
Headlight Bucket Spring	84		
Headlight Cover Shield	1		
Headlight Dimmer Switch	41, 85		
Headlight Dimmer Switch Screws	85		
Headlight Door Mounting Kit	85		
Headlight Door Screw	85		
Headlight On Warning Kit	41		
Headlight Retaining Ring	84		
Headlight Switch	41, 85		
Headlight Visor	1		
Headliner	75		
Headliner Glue	94		

Index

Inner Tie Rod	107	Mirror Mounting Kit	90
Inner Trunk Brace/Bracket	103, 123	Mirrors	89-90
Inner Wheel Bearing Grease Seal	11	Molding Clip	17, 18
Instrument Bezel Lens	29, 81	Motor Mount	48
Instrument Cluster Voltage Regulator	39		
Instrument Gauge Insulator	29, 39	Neutral Safety Switch	41, 119
Instrument Panel Lamp Socket	29, 39		
Insulation - Foil Back	75	Oil Cap	48
Interior	74-82	Oil Cap Adapter Tube	48
Interior Door Handles	36	Oil Filter	47
		Oil Filter Cover	47
Jack Assembly	122	Oil Pan	49
Jack Folding Handle	122	Oil Pan Gasket	49
		Oil Pan Hardware	49
Key Blanks	88	Oil Pressure Sending Unit	49
Key Chain	2	Oil Pressure Sending Unit Extension	49
Kick Down Control Shaft Spring	119	Oil Pump	49
Kick Panels	80	Oil Pump Pickup Screen	49
		Oil Pump Shaft	49
License Plate Bracket	54	Output Shaft Oil Seal	119
License Plate Frames	2	Outer Tie Rod	107
License Plates	2	Owners Plate	2
License Plate Bolts	2		
Lighting Pigtails	87	Package Tray Insulation	75
Lights	83-87	Package Tray	75
Literature	131	Package Tray Retainer	75
Lithium Grease	93	Paint & Restoration Supplies	91-94
Locks	88	Paint Marker Set	93
Lower Ball Joint Dust Seal	111	Parking Brake Cable	15
Lower Control Arm Bushing	111	Parking Brake Cable Clip	15, 19
Lower Control Arms	111	Parking Brake Cable Connector	16
Lower Wheelhouse Patch Panels	103	Parking Brake Cable Equalizer	16
Lug Nuts	128	Parking Brake Cable Idler	16
		Parking Brake Equalizer Rod	16
Magnetic Signs	2	Parking Brake Lever	9
Magnum 500 Paint Decal	127	Parking Brake Lever Lock Clip	9, 19
Magnum 500 Spinners	127	Parking Brake Pedal Pad	12
Magnum 500 Wheels	127	Parking Brake Pedal Pad Trim	12
Manual Shift Knob	28	Parking Brake Pulley	16
Manual Shift Knob Lock Nut	28	Parking Brake Ratchet Pawl	16
Manual Shift Lever Insulator	28	Parking Brake Ratchet Pawl Spring	16
Manual Steering Adapter	106	Parking Brake Spring Retainer	10
Manual Transmission Gasket Kit	119	Parking Lamp Socket	42, 87
Manual Transmission Rebuild Kit	119	Parking Light Lens	86
Marker Light Lenses	85	Parking Light Lens Gasket	86, 126
Marker Light Socket	41	Passenger Sport Mirror Hardware	89
Marker Light Stud Protectors	86	PCV Elbow	49
Master Cylinder Boot	15	PCV Hose	49
Master Cylinder Cap Gasket	14	PCV Valve	50
Master Cylinder Rod Bushing	15	Pertronix Ignitor	39
Master Cylinder	14	Pilot Bearing	22
Mirror Bezel Nut	90	Pinion Bearing Oil Seal	113
		Pitman Arm to Steering Sector Nut	104

Index

Pittman Arm	104	Rear Shock Upper Mount Bolt	113
POR 15 Products	91-93	Rear Shock Upper Mount Bolt Nut	70
Power Brake Booster Seal	14	Rear Spring Anti-Squeak Pad	112
Power Steering Bracket Spacer	105	Rear Spring Bushing Bolt	112
Power Steering Control Valve	105	Rear Spring Clamp Kit	112
Power Steering Control Valve Cap	105	Rear Spring U-Bolt	113
Power Steering Cylinder, Reman.	107	Rear Valance - Option	103
Power Steering Hose Insulator	105	Rear Valance Tag Bumpers	100
Power Steering Hose Protector Sleeve	106	Rear Window Gasket	125
Power Steering Hydraulic Hose	106	Rearview Mirror	89
Power Steering Pump Cap	105	Rearview Mirror Adhesive	94
Power Steering Pump Seal/Gasket Kit	105	Rearview Mirror Bracket	89
Power Steering Pump Spray Paint	91	Rearview Mirror Bracket Adhesive	89
Power Steering Return Hose	106	Remote Mirror Nut Removal Tool	90
Push Rod/Stop Light Switch Spacer	15	Repair Manuals/Books	131
		Retainers	20-21
Quarter Panel	102	Rimblow Steering Wheel Gap Cover	77
Quarter Panel Drain Plugs	100	Roof Rail Seals	124
Quarter Window Seals	125	Rubber Bumper Kit	100
Quarter Panel Extension Seals	126	Rubber Bumpers/Plugs/Grommets	99-101
		Rubber Plugs	100
		Rubberized Undercoating	91
Radiator	95		
Radiator Cap	95	Sail Panel Insulation	75
Radiator Drain Valve	95	Screws, Filler Pipe Seal	56
Radiator Fan	95	Scuff Plate	77
Radiator Hose Clamp	96	Scuff Plate Label	77
Radiator Support Bumpers	100	Scuff Plate Screws	77
Radiator Support to Hood Seal	124	Seam Sealer	93, 94
Radiator Support	103	Seat Back	79
Radio	98	Seat Back Hardware	79
Radio Knobs	30, 97	Seat Belt Button Decal	79
Radio Supressor	98	Seat Belt Retractors	80
Rear Axle Bumper	99, 113	Seat Belt Shoulder Bolt Cover	80
Rear Axle Housing Gasket	113	Seat Belts	79
Rear Axle Seal	11	Seat Foam	79
Rear Axle Vent	113	Seat Hinge Covers	79
Rear Brake Spreader Bar	10	Seat Latch Release Handles	79
Rear Brake Spreader Bar Spring	10	Seat Self Adjusting Knob	79
Rear Bumper Brackets to Body Pads	126	Seatbelt Bolt	67
Rear Defogger Switch Knob	30	Sector Worm Shaft Bearing	104
Rear Leaf Bushing Bolt	112	Self Adjusting Kits	9
Rear Leaf Spring Centering Bolt	112	Self Etching Primer	92
Rear Leaf Spring Clamp Kit	112	Selt Belt Restoration Kit	79
Rear Leaf Spring Front Bushing	112	Sheetmetal	102-103
Rear Leaf Springs	112	Shift Lever Cable	27
Rear License Lamp Assembly	42, 86	Shift Lever Insulator	28
Rear License Lamp Lens	86	Shift Lever/Linkage Bushing	119
Rear Marker Light Lens Gaskets	86, 126	Shift Linkage Repair Kit	25, 118
Rear Marker Light Stud Protectors	86, 123	Shift Selector Lens	28, 77
Rear Marker to Body Gaskets	86, 126	Shift Shaft Seal	119
Rear Package Tray	75	Shock Tower Cap Bolt/Nut Set	112
Rear Quarter Ash Tray	74	Shocks	113
Rear Shackle Kit	113	Snap Plug Connector	38
Rear Shackle/Spring Bushings	113	Spacer Plate Adapter Kit - T-5	25

Index

Spare Tire "J" Bolt	122	Sunvisor Tips	78
Spare Tire Bolt Bracket	102, 122	Sunvisors	78
Spare Tire Bolt Wing Nut	122	Suspension	110-113
Spark Plug Wire Loom Kit	50	Sway Bar Bushings	111
Spark Plug Wires	50	Sway Bar End Link Kit	112
Spark Plugs	50		
Speaker Grille	97		
Speakers	30, 97, 98	Tail Light Socket	42, 87
Speedometer Cable	93, 116	Tailight Lens Gasket	86
Speedometer Cable Gear Retainer	117	Tailight to Body Gasket	86
Speedometer Cable Gears	117	Taillight Lens Gasket	126
Speedometer Cable Grommet	101, 116	Temperature Control Cable	73
Speedometer Cable Lube	116	Thermostat	48
Speedometer Cable Retainer	116	Thermostat Housing	47, 95
Speedometer Cable to Trans. Clamp	116	Thermostat Housing Gasket	47, 95, 126
Speedometer Drive Gear	117	Thermostat Housing Hardware	47, 95
Speedometer Head Gasket	29	Thermostats	48, 95
Sport Mirror Adjustment Wand	90	Tie Rod Adjusting Sleeves	107
Sport Mirror Bezel Nut	35, 90	Tie Rod End Dust Seal	107
Sport Mirror Gaskets	90	Timing Chain	48
Sport Mirror Hardware	89	Timing Chain Cover	48
Sport Mirror Lens	89	Timing Chain Cover Gasket	48
Sport Mirror Retaining Washer	90	Tin Signs	1
Sportlamp Toggle Switch Knob	30	Tire Covers	123
Spring Seat Bushing	110	Tool Kit Bag	123
Starter Bolt	64	Tools	114-115
Starter Solenoid	42	Torque Converter Flange Nuts	118
Starting Sleeve	80	Tote Bag	123
Steering	104-107	Traction Bars	112
Steering Bracket to Frame Crush Nut	105	Transmission	116-120
Steering Column to Firewall Seal	124	Transmission Cooler Lines	118
Steering Column Tube Bearing	104	Transmission Crossmember	117
Steering Cylinder Boot Insulator	105	Transmission Dipstick Tube	117
Steering Cylinder Seal Kit	105	Transmission Dipstick	117
Steering Gearbox Washer	107	Transmission Filter Kit	116
Steering Sector Bushing/Bearing	104	Transmission Inspection Plate	116
Steering Sector Cover Gasket	104	Transmission Linkage Clip	118
Steering Sector Shaft Oil Seal	104	Transmission Mount	117
Steering Slave Cylinder Boot & Clamp	105	Transmission Oil Cooler Line Clips	19, 118
Steering Wheel	76	Transmission Oil Cooler Line Fittings	95, 118
Steering Wheel Horn Pad	76, 77	Transmission Pan	116
Steering Wheel Nut	77	Transmission Pan Bolts	116
Steering Wheel Trim Inserts	77	Transmission Pan Gasket	116
Stone Guard	103	Transmission Rebuild Kit	119
Striker Plate	37	Transmission Gears	120
Striker Plate Screws	37	Transmission Vacuum Modulator	118
Stripes & Graphics	108-109	Transmission Vacuum Line	118
Strut Rod	111	Trim Spray Adhesive	91
Strut Rod Bushings	111	Trunk	121-123
Strut Rod Nuts	111	Trunk Divider	75, 123
Style Steel Wheels	127, 128	Trunk Floor Board	122
Sunvisor Anchor Pin	78	Trunk Floor Grommets	122
Sunvisor Arm & Bracket Assembly	78	Trunk Floor Metal Plug	122
Sunvisor Bracket Screws	78	Trunk Latch	121
Sunvisor Center Clip	78	Trunk Letters	54
Sunvisor Center Clip Screws	78	Trunk Lid Bumpers	100, 121

Index

Trunk Lid Catch	121	Wheel Bearing Grease	93
Trunk Light	41, 87, 121	Wheel Center Caps	127, 128
Trunk Light - OEM Style	42, 87, 121	Wheel Center Decals	128
Trunk Lock	88, 121	Wheel Cylinders	10
Trunk Lock Gasket	88, 121	Wheel Studs	128
Trunk Lock Retainer	121	Wheels	127-128
Trunk Lock Stem	121	Window Crank Handle	36, 82
Trunk Mat	122	Window Crank Handle Knob	36, 82
Trunk Release Kit	2	Window Handle Crank Knobs	36, 82
Trunk Seal	121, 125	Window Handle Escutcheon	36, 82
Turn Signal Lever	80	Window Handle Screw	36, 82
Turn Signal Switch	42	Window Handle Screw Cover	36, 82
Turn Signal Switch Connector	42	Window Regulator Arm Roller	37
		Window Stop Bumper	37, 99
U-Joint	120	Windshield	55
Under Hood Cover	52	Windshield & Body Sealant	94
Upper Arm Spring Seat w/Bushing	110	Windshield Gasket	55, 124
Upper Ball Joint Dust Seal	110	Windshield Molding Clip	17
Upper Control Arm Ball Joint	110	Windshield Wiper Knob	30
Upper Control Arm Bolt	111	Wiper Arm Linkage Clip	20, 130
Upper Control Arm Shaft Bolt	111	Wiper Arms	129
Upper Control Arm Shaft Bolt Nut	111	Wiper Blade	129
Upper Control Arm Shaft Kit	111	Wiper Blade Refills	129
Upper Control Arm Zerk Fittings Kit	111	Wiper Knob	30, 130
Upper Control Arms	110	Wiper Motor	43, 130
		Wiper Motor Arm	130
Vacuum Modulator	118	Wiper Motor Gear Cover	130
Valve Cover Bolts	50	Wiper Pivot Shaft Seals	129
Valve Cover Gasket	51	Wiper Switch	43, 130
Valve Cover PCV Grommet	49, 101	Wipers	129-130
Valve Covers	51	Wire Dividers	50
Valve Stem Caps	128	Wiring Retainers	44
Valve to Cylinder Hydraulic Hose	106	Wiring Strap	44
Vapor Canister Hose	59	Woodgrain Horn Switch Trim Plate	76
Vinyl Spray Paint	91		
Vinyl Top	55		
Voltage Regulator	43		
Voltage Regulator Bolt Set	64		
Voltage Regulator Pigtail	43		
Washer Bottle	129		
Washer "F" Tee	129		
Washer Hose Kit	129		
Washer Nozzle Screws	129		
Washer Pump Harness Connector	44		
Washer Reservoir Pump	129		
Water Neck Bolts	64		
Water Pump Pulley	49		
Weatherstrip Adhesive	94		
Weatherstrip Kit	125		
Weatherstrip Retainer	125		
Weatherstripping	124-126		
Wheel Bearing & Race	11		

CLUB INFORMATION

DIXIE MAVERICK
www.dixiemaverick.com

MAVERICK COMET CLUB INTERNATIONAL
www.maverickcometclub.org

MAVERICK COMET GROUP
www.maverickcometgroup.com

CAMEO – COMET AND MAVERICK ETHUSIAST ORGANIZATION
www.cameoclub.com



FORD MAVERICK/MERCURY COMET FORUM
<http://mmb.maverick.to>

The largest Ford Maverick and Mercury Comet community
and photo gallery on the web.

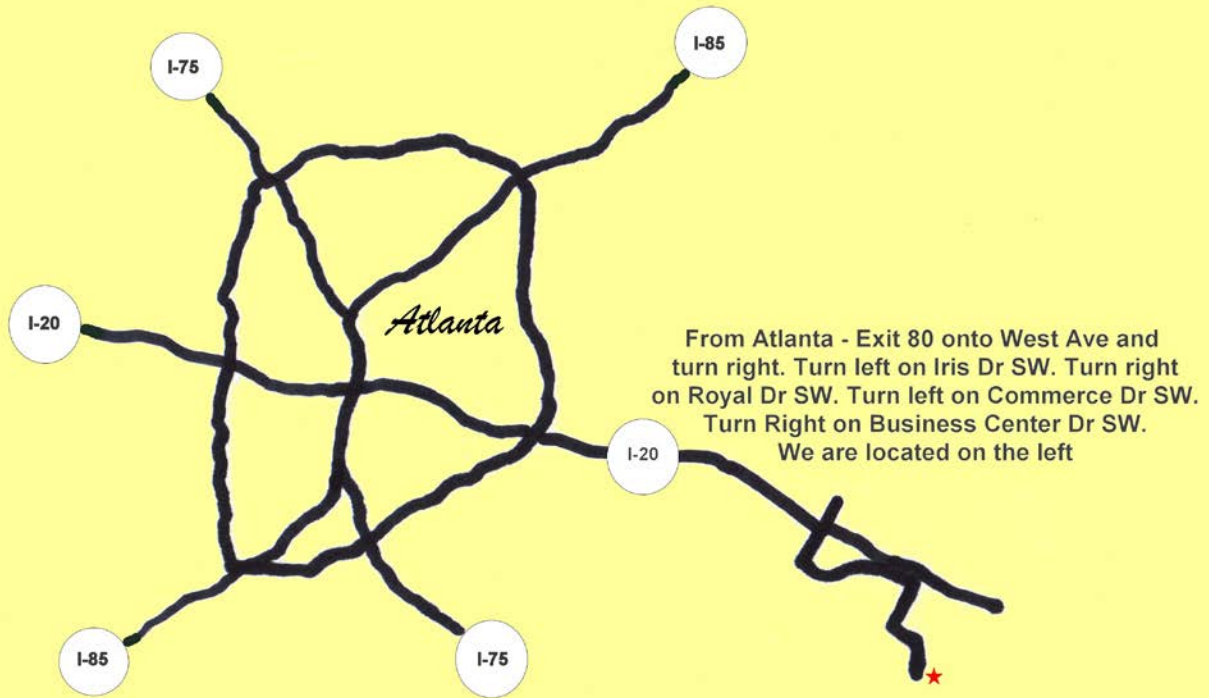

Stop by and visit, we are 25 minutes from
Hartsfield International Airport and only 30 minutes
from downtown Atlanta
Large enough to serve you - small enough to care.

We sell parts for: 1964 ½-73 Mustang, 1928-79 Truck, 1962-71 Fairlane, 1928-59 Ford Car
1960-70 Ford Galaxie, 1955-66 Thunderbird, 1970-77 Ford Maverick, 1971-77 Mercury Comet
1960-70 ½ Falcon, 1960-66 Ranchero & 1967-73 Mercury Cougar.

Internet Website: www.melvinsclassicfordparts.com